



**HAL**  
open science

## **Towards Embroidered Circuit Board From Conductive Yarns for E-Textiles**

Ezgi Ismar, Xuyuan Tao, François Rault, François Dassonville, Cédric Cochrane

► **To cite this version:**

Ezgi Ismar, Xuyuan Tao, François Rault, François Dassonville, Cédric Cochrane. Towards Embroidered Circuit Board From Conductive Yarns for E-Textiles. IEEE Access, 2020, IEEE Access, 8, pp.155329-155336. <10.1109/ACCESS.2020.3018759>. <hal-04506773>

**HAL Id: hal-04506773**

**<https://lilloa.hal.science/hal-04506773v1>**

Submitted on 15 Mar 2024

HAL is a multi-disciplinary open access archive for the deposit and dissemination of scientific research documents, whether they are published or not. The documents may come from teaching and research institutions in France or abroad, or from public or private research centers.

L'archive ouverte pluridisciplinaire HAL, est destinée au dépôt et à la diffusion de documents scientifiques de niveau recherche, publiés ou non, émanant des établissements d'enseignement et de recherche français ou étrangers, des laboratoires publics ou privés.



Distributed under a Creative Commons CC BY 4.0 - Attribution - International License

Received May 15, 2020, accepted July 29, 2020, date of publication August 24, 2020, date of current version September 4, 2020.

Digital Object Identifier 10.1109/ACCESS.2020.3018759

# Towards Embroidered Circuit Board From Conductive Yarns for E-Textiles

EZGI ISMAR<sup>ID</sup>, XUYUAN TAO<sup>ID</sup>, FRANÇOIS RAULT<sup>ID</sup>, FRANÇOIS DASSONVILLE,  
AND CÉDRIC COCHRANE<sup>ID</sup>

École Nationale Supérieure des Arts et Industries Textiles/Génie et Matériaux Textiles Laboratoire (ENSAIT/GEMTEX), 59100 Roubaix, France

Corresponding author: Xuyuan Tao (xuyuan.tao@ensait.fr)

The work of Ezgi Ismar was supported by the Fonds Européen de Développement Régional/Met steun van het Europees Fonds voor Regionale Ontwikkeling in the framework of the European Interreg V France-Wallonie-Vlaanderen Project Luminoptex.

**ABSTRACT** In this study, polymeric/metallic yarns were fabricated by using the micrometric copper multifilament and the polymer multifilament to create electrically conductive, thin, flexible composite yarn structures. The main aim is to realize the circuit board by using fabricated conductive yarns in the needle position of the embroidery machine and to integrate electronic components on textile structures by the soldering process. In the embroidery machine, the usage of the yarn in the needle gives a chance to create a tailored design according to the specified application. Mechanical and electrical properties of fabricated yarns were investigated. Meanwhile, a benchmark test has been done by using other commercial conductive yarns. Their embroidery performances were tested by investigating the possible harms during the stitching process. Finally, several embroidered circuit boards have been realized to show the versatility of fabricated yarns for different circuit designs.

**INDEX TERMS** Conductive yarn, e-textiles, electronic circuits, embroidery process, textile industry, textile products.

## I. INTRODUCTION

E-textiles are characterized by the convergence of different disciplines, such as material, electronic and automation sciences. They aim to combine the electrical properties and/or functions with flexible textile substrates. From healthcare to entertainment e-textiles have a wide range of potential applications [1]. With the development of material science and electronic engineering, as an important e-textiles sector, wearable textile electronic devices are tremendously miniaturized and their form moves from bulky and rigid to thin and flexible [2]. Nevertheless, the integration of electronic components is always an obstacle in terms of end-use applications. There are two main issues for the integration: the high conductive yarn and the connection technology between textiles and electronic components [3]. Conductive yarns are one of the most popular joining elements of the e-textile system. They can be shaped as a wire, staple fiber or filament. Their source can be 100% electrically conductive metals such as stainless steel, copper, aluminum, etc. or intrinsic conductive polymer (ICP) such as PEDOT:PSS

(poly(3,4-ethylene dioxythiophene) polystyrene sulfonate), polypyrrole, etc. or conductive polymer composite (CPC) such as silver-based, carbon-based, etc.. Some of them are fabricated directly through their raw material while others are fabricated via modification of non-conductive fibers or filling of non-conductive materials [4], [5]. There are several commercial conductive yarns in the market, such as silver-plated yarns, stainless steel, metallic yarns, and carbon fiber yarns [6]–[9].

Polymer containing conductive yarns can be obtained via coating with conductive material or spinning through the conductive material [10]–[13]. Silver-plated polymeric yarns are one of the most common conductive yarns due to their flexibility and ease of processability when they are compared to metal-based yarns. Polyamide fibers covered with a thin layer of silver present high conductivity while preserving the flexibility of the polyamide [14]. They are widely used to realize the textile circuit board by embroidery technology [15]–[17]. However, silver-plated yarns exhibit poor adhesion properties [18]. As a result, during the embroidery processes where external forces will be applied, the silver coating starts to be damaged and to peel off by losing its conductivity [19]. Moreover, coated/plated polymeric conductive yarns are not

The associate editor coordinating the review of this manuscript and approving it for publication was Jenny Mahoney.

convenient for the soldering process due to the applied high temperature [20]–[22].

Besides of coating process, the melt or wet spinning process is employed to obtain the conductive yarn by mixing the powder of inherently conductive polymers such as carbon black or nanotube with polymers to obtain fibers [23], [24]. However, their electrical conductivity is not enough high for the electric transmission requirement. Apart from the silver-coated polyamide yarns, insulated copper yarns have been widely used to create electrical circuits in textile structures [25]–[27].

Metal-based yarns have a superior electrical conductivity over inherently conductive polymeric yarns. As a drawback, the sensation of metallic fibers on the skin is not very comfortable and they are not very flexible to process. For this reason, metallic fibers are preferred to use as a mixture with the conventional yarns and fabrics instead [28], [29]. They are usually used by inserting into the fabric during the weaving or knitting process [30]–[32]. However, since their low elasticity and flexibility, it's quite difficult to use metallic yarns in the embroidery process compared to polymer-based yarns. The stainless yarn has been developed several years ago and widely used for smart textile applications. However, it cannot be used in needle position for sewing and embroidery process. The use of yarn in needle is to be preferred not only for the aesthetics of the embroidery but also for the manufacturing process. The inconveniences of use in spool position are: 1) the length of yarn is limited by the size of spool bobbin 2) the sewn design cannot be well controlled for spool bobbin yarn. Besides, the stainless yarn is not suitable for solder. In this study, we aim to overcome this issue.

As for the integration issue, there are several connection technologies for the textile structure and electronic components, such as gluing [33], [34], flip-chip [35], [36], crimping [37], embroidering [38], [39], soldering [40], magnet [14], etc. Some of them are not suitable for polymer-based conductive yarns because of the requirement of high temperature. As for embroidery technology, only polymer-based conductive yarns can be used in the needle position. Best of the authors' knowledge and experience, 100% metal-based yarns such as stainless steel can be only used in the spool position. Electronic components are soldered on a flexible or semi-flexible PCB (Print Circuit Board) and then the contact process is made by the physical contact between conductive yarn and the pad of PCB [41], [42]. If the conductive yarn can be only used in the spool position, it's difficult to create this physical contact. Meanwhile, even if polymer-based conductive yarns are used in the needle position, the contact part will be loose during the use. As a result, this kind of contact results in a high contact electric resistance or even a failure of contact [41]. Hence, this contradiction limits the development of integration of electronic component on textile structures for decades.

Till now, there is not any commercial e-textile product with directly attached electronic components in the market. The reason of the lack of fully developed e-textile product

is that there is no reliable technology to integrate the electronic component directly on the textile structure. Most of them are realized by snap buttons. The second reason is that there is no highly conductive thread compatible with sewing or embroidery process, which limit the conductive flexible circuit design. Conventional textile products have a flexibility feature which makes them easy to wear and use whereas electronic products have a certain rigidity. The most common challenge to meet the conventional textile products with the electronics is to overcome the flexibility issue for electronic components. In order to make consumers to accept e-textiles, it must disrupt their user experience and habits as little as possible. As a result, the usual properties must be guaranteed: comfort, durability, washability, etc.

In this manuscript, the main aim is to realize the complex circuit board by using novel yarns which can be used in the embroidery process in the needle position. Mechanical and electrical properties of fabricated yarns were investigated by comparing with other commercial conductive yarns. Their embroidery performances were tested by investigating the possible harms during the stitching process. Finally, several embroidered circuit boards have been realized to show the versatility of fabricated yarns for different circuit designs.

## II. MATERIALS AND METHODS

The novel yarn is made of copper wires (Elektrisola, Switzerland), and Lenzing Profilen® PTFE (Polytetrafluoroethylene) monofilament (Lenzing Plastics GmbH, Austria). The Profilen® monofilaments were used as core yarn to support the very thin copper wires to improve the processability. Moreover, polyester multifilaments were used as a cover layer to protect copper wires and make ease of their movement through the needle and embroidery process. The reason of choosing polyester multifilaments as cover yarn is that they are most popular used as embroidery thread in embroidery and sewing process because of their low price and high mechanical properties.

Fig. 1 illustrates the fabrication process. The hollow spindle machine (Gualchieri e Gualchieri, Italy) was used to fabricate the conductive yarns. The Lenzing Profilen® PTFE

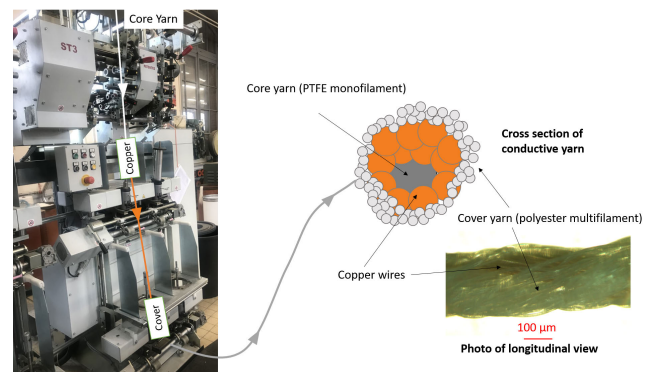

**FIGURE 1.** Conductive yarn fabrication process by the spinning machine and the cross-section illustration of fabricated yarns.

monofilament was fed from the top of the spinning machine as a core yarn and top spindle speed is 4000 rpm. Multifilament copper wires were twisted over the core yarn in the middle position of the machine. Twist of the copper wires was set as 400 TPM (Turns Per Meter). The polyester multifilaments were used as cover yarn with 600 TPM over the copper wires. After cover yarn twisted, fabricated yarns wind through the bobbin and this process named as winding process and yarn collected on the bobbin. The fabrication process is carried out under room temperature, 50-65% relative humidity.

In this manuscript, two kinds of conductive yarns were fabricated: the one with  $12 \times 30 \mu\text{m}$  copper wire as type A, and the other one is  $30 \times 20 \mu\text{m}$  copper wire as type B.

Three commercial conductive yarns were purchased and used as they received for benchmark test to compare with the fabricated yarns. They are Madeira HC40 (Madeira Garnfabrik GmbH, Freiburg, Germany), Shieldex 117/17-2 ply HCB (Statex Produktions+Vertiebs GmbH, Bermen, Germany), and Tibtech Datatrans yarn (TIBTECH innovations, France). The ordinary  $135 \times 2$  dtex polyester yarn (Gunold, Germany) which is commonly used in the embroidery machine was also tested to obtain the reference value for the embroidery machine.

Mechanical propriety measurements were carried out with MTS Criterion® Electromechanical Universal Test Systems (Criterion, US) according to ISO 2062 standard. The number of trials is 10 samples and the length of the sample is 200mm with the applied speed of 200mm/min.

The electrical conductivity measurements of the samples were performed with the 1906 computing multimeter (Thurlby Thonder Instruments). For all kinds of yarns, 10 samples were tested for various distances between 10 cm and 100 cm, and each measurement was repeated 10 times to obtain the average values. After the embroidery process, conductive yarns were carefully pulled out from the fabric and their linear resistance was measured to investigate the resistance change on the yarn. Since the applied mechanical force, such as bending, stretching, friction, during embroidery process will be much strong than the one during pullout process, we consider that the damage during pullout process can be negligible.

The embroidered process was carried out in JF-0215 ZSK embroidery machine (ZSK Stickmaschinen GmbH, Krefeld, Germany). The distance between stitch points is 2.5mm, which is controlled by the embroidery machine. To investigate the embroidery performance of the yarns, complex design with straight and curved were applied. All yarns are used in the needle of the embroidery machine except for Tibtech yarn because it is too tense which makes it not applicable in the needle position. Due to that, Tibtech yarn, which was used in the spool position.

Three kinds of textile-based circuits were fabricated on cotton fabrics. The connection between the conductive yarn and electronic components were realized by soldering technology with a low melting point solder ( $179^\circ\text{C}$ ) (SN62 362 5C, Loctite). The textile-based circuit was connected to a

microcontroller by snap buttons. 100 Ohm 0805 resistors (TRU components), VLD 1232G LEDs (Vishay), 1206 CMS LED (VCC), SN74HCT573N chip (Texas Instruments) and SN74HC595N chip (Texas Instruments) were used for circuit board applications. Arduino UNO and Micro microcontrollers were used to control the components. The temperature of circuit has been measured by an infrared thermometer (Fluke VT04A, Washington, United States).

### III. RESULTS AND DISCUSSIONS

#### A. MECHANICAL PROPRIETIES

The results of the mechanical measurements of the yarns were shown in Fig. 2. Copper wire twisted yarns have improved mechanical properties when it is compared with the core yarn. The yarns A and B show a brittle curve (strength of yarn A slightly higher than yarn B) and the ordinary embroidery yarn has a ductile curve, which means that the copper wires reduce the elongation and increase the strength for the core yarn because the copper wire is not flexible due to its metallic nature and it has a lower elongation percentage over the other yarns. Silver-plated yarns (Shieldex and Madeira) have a similar mechanical performance. They are less elastic than ordinary polyester yarn but more elastic than others. Among the all conductive yarns, the silver-plated yarns give the closest mechanical performance to the ordinary polyester yarn. The Tibtech yarn is not as tough as fabricated yarns A and B, but not also too much elastic.

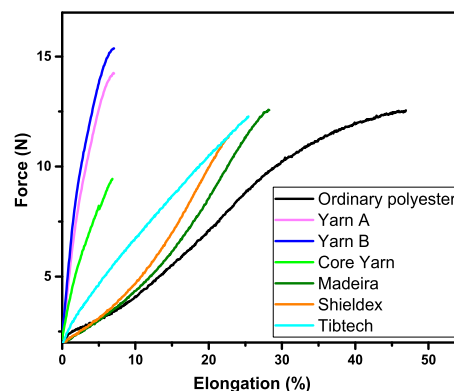

FIGURE 2. Average stress-Strain test results of different yarns.

In terms of recovery and resilience performance, the flexibility of the yarn determines the ease of the yarn movement during the embroidery process. If the yarn is too rigid, it will be impossible to make the loop under the fabric. Otherwise, if the yarn is too elastic, it will not create the loop under the fabric during the stitching and make entanglements. The core yarn has a high Young's modulus (17.71 GPa), which makes it impossible to be used in embroidery machines. However, combined with copper wire and cover yarn, its Young's Modulus (7.21 GPa for yarn A and 5.94 GPa for yarn B) is close to ordinary polyester (4.2 GPa). The ordinary embroidery yarn is the most elastic one compared to others. However, fabricated yarn A and B work well with the embroidery

TABLE 1. Results of mechanical tests of yarns.

Yarn Name	Diameter (mm)	Breaking Point (%)		Young's Modulus (GPa)	
		Avg.	Std.	Avg.	Std.
Ordinary polyester	0.15	39.56	1.6	4.2	0.5
Core Yarn	0.11	9.89	1.4	17.71	1.0
Madeira	0.20	38.17	1.1	2.27	0.1
Shieldex	0.18	32.74	0.8	2.46	0.1
Tibtech	0.38	32.04	2.1	0.46	0.03
Yarn A	0.23	8.72	0.6	7.21	0.2
Yarn B	0.28	8.64	0.6	5.94	0.4

machine. The diameter of Tibtech yarn is too high to be used in needle position, even if its mechanical performance is close to ordinary yarn.

**B. ELECTRICAL PROPRIETIES**

Fig. 3 shows the measurement of the linear electrical resistance values of the yarns with error bars. The linear resistances are given by the slopes of the linear regression. Among all commercial conductive yarns, Shieldex yarn possesses the highest resistance value with 247 ohm/m. The linear resistance of Madeira is 114 ohm/m. Tibtech yarn has a low linear resistance value around 4.1 ohm/m. Yarn A has electrical conductivity value as 2.3 ohm/m and yarn B has an electrical conductivity value as 2.3 ohm/m.

For all conductive yarns, their resistance grows linearly with the measured length. The statistic result shows that the data follow the linear regression model with high R-squared value, which means that they exhibit a good homogeneity.

**C. EMBROIDERY PROPRIETIES**

Straight and curve embroidery designs were prepared for all yarns to evaluate their embroidery performance. Except for Tibtech yarn, the other yarns were used in the needle position. Tibtech yarn is so stiff which makes it impossible to be used in the needle position. Hence, it is used in the spool position. Fig. 4 presents the front view of the embroidered samples and Fig. 5 shows the back side of the embroidered designs. During the embroidery process, not any broken yarn was observed and the distance between the stitches is homogenous.

In Fig. 5b and 5c, the silver-plated yarns can be observed in the curved part of the design from the back side, which is due to the tension problem of the yarn. For yarn A and B (Fig. 5e and 5f), the back side is smoother and more homogenous and similar to the ordinary yarn sample (Fig. 5a) which shows that fabricated yarns can be used in the embroidery machine during the mass production.

The results of linear resistances of conductive yarns after the embroidery process are given in Fig. 6. As for the linear resistance of the yarns, there was a slight difference before and after the embroidery process. Resistance values became a little higher after the embroidery. It can be explained by

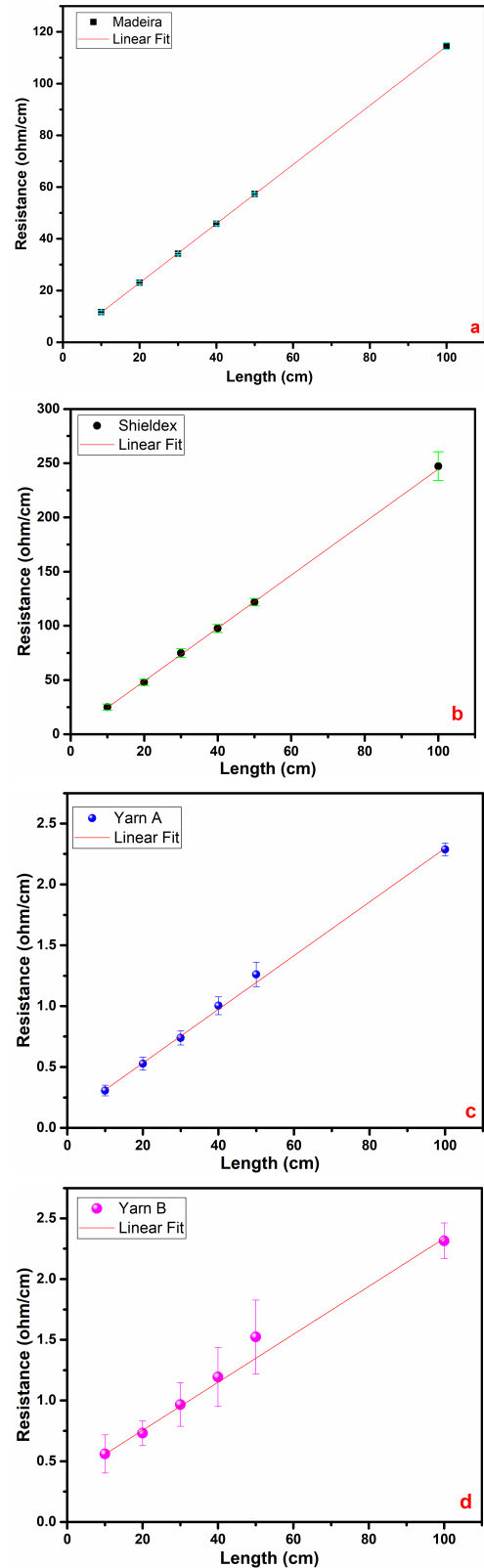
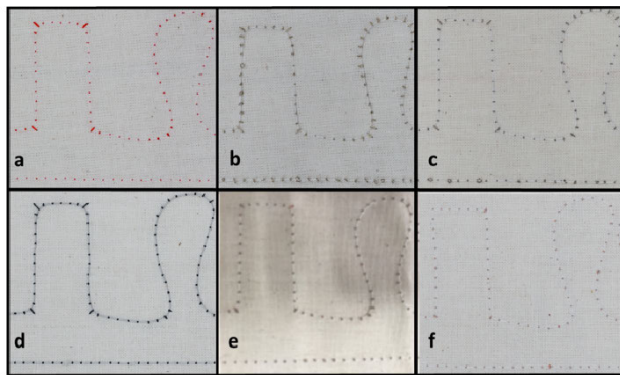

FIGURE 3. Linear Electrical Resistance values of the yarns a) Madeira, b) Shieldex, c) Yarn A, and d) Yarn B.

the mechanical forces and friction actions applied to the yarn during the embroidery process. However, curved embroidery lines had a lower resistance value when they were compared



**FIGURE 4.** Embroidery performance of the different yarns, a) Ordinary embroidery yarn, b) Madeira, c) Shieldex, d) Tibtech as a bobbin yarn, e) Yarn A, and f) Yarn B.



**FIGURE 5.** Back side of the embroidered samples a) Ordinary embroidery yarn, b) Madeira, c) Shieldex, d) Tibtech as a bobbin yarn, e) Yarn A, and f) Yarn B.

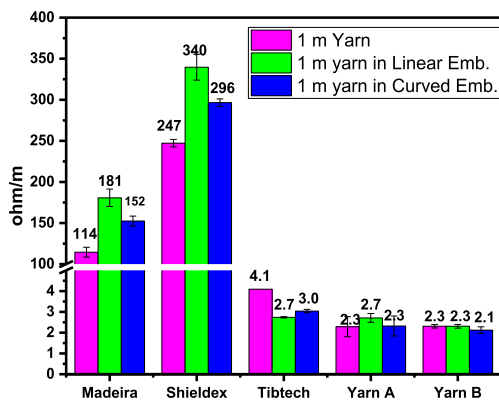

**FIGURE 6.** Resistance (ohm/m) comparison of the 1 m length yarn as a yarn form, in the straight line embroidery stitch, and curved embroidery stitch.

to the straight embroidery lines. This can be explained with the curvy design was more appropriate with the embroidery stitching movement than the straight stitching.

#### D. TEXTILE-BASED CIRCUIT

Since there is no difference between the conductive yarn type A and B, we use the yarn type A to realize all textile-based circuit applications.

Fig. 7 shows the demonstration of conductive yarn and LED (1206 CMS LED) in the embroidery design. A CR2032 battery was used as a power supply. The conductive was covered by polyester yarns (back color). The LED was soldered with the conductive yarn.

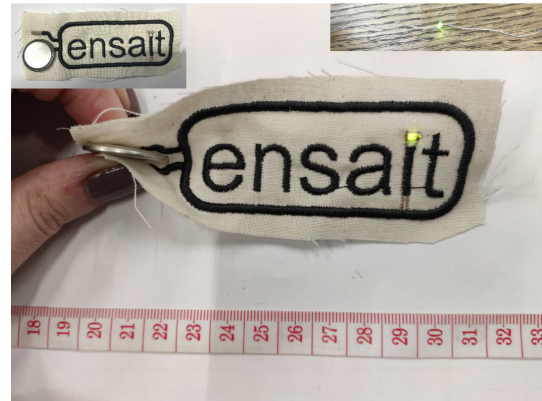

**FIGURE 7.** Photograph image of the embroidered ENSAIT logo with the usage of the fabricated yarn A with the LED attachment.

The second application is about six LEDs (VLD 1232G LED) parallelly connected with the Arduino Micro micro-controller (Fig. 8). Snap buttons were used to connect the textile conductive yarn and metal wires. The Arduino Micro is programmed to have a dynamic blinking effect. The video of the dynamic blinking demonstration is offered as the supplementary material.

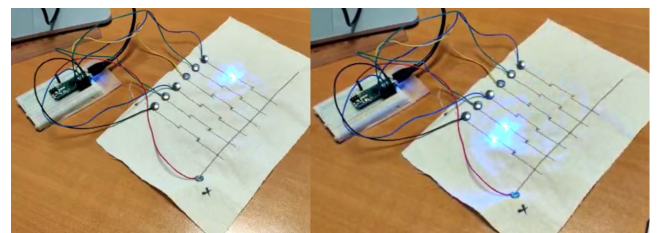

**FIGURE 8.** Photograph image of the six parallelly connected LEDs with Arduino Micro device.

Fig. 9 shows the sixteen LEDs connected with an Arduino UNO micro-controller. Two octal Transparent D-Type latches (SN74HCT573N) and an 8-bit shift with 3-state output register (SN74HC595N) were used to realize this circuit. The circuit schema is shown in Fig. 10. The D-type latch and registers were PDIP (Plastic Dual in-Line Package) package. To make them compatible with the solder process, the leads of devices were bent to make gull wing format. As a result, the device can be easily soldered on the conductive yarn. Since there were crisscross patterns for the conductive yarns, ordinary embroidery yarns were to realize an isolator spacer

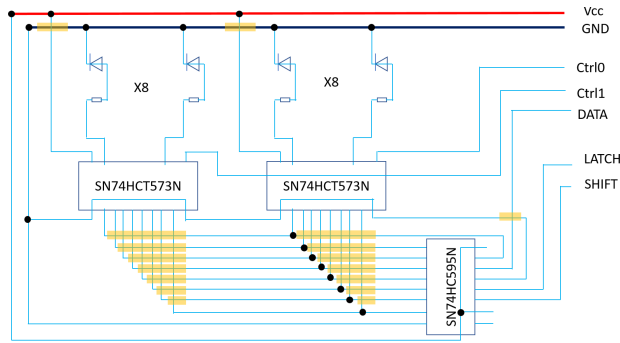

FIGURE 9. Circuit schema of sixteen LEDs application.

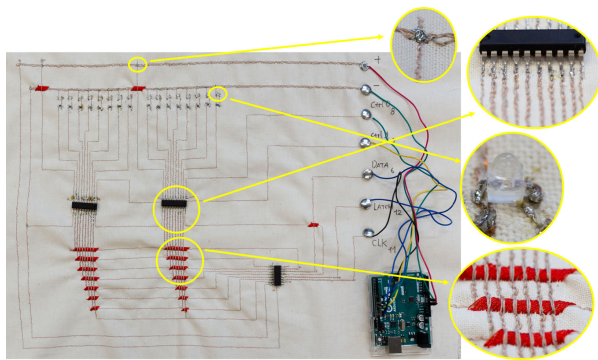

FIGURE 10. Photograph image of the sixteen parallelly connected LEDs with Arduino Uno device and electronic components.

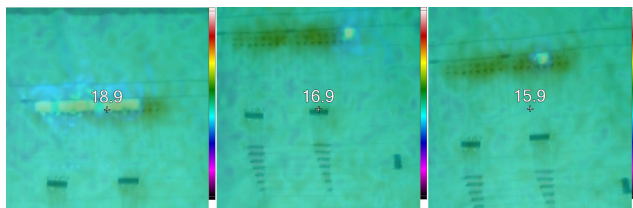

FIGURE 11. Infrared thermometer image of the sixteen LED circuit.

between conductive yarns (red part in Fig. 9 and yellow part in Fig. 10) in order to avoid the short circuit effect. This kind of design offers a multiple-layer possibility for circuit design. On the other hand, a solder point was added on the battery supplier bus and the conductive yarn in order to enhance the electrical contact. The video of the dynamic blinking demonstration is offered as the supplementary material.

The temperature of sixteen LEDs circuit has been measured 30mins after the run of the circuit (Fig. 11). The environment temperature was 15.9 °C. The highest temperature of circuit has been measured on the LED devices, which was 18.9 °C. The temperature on chip was about 16.9 °C. The temperature of circuit is not dangerous for the human skin.

#### IV. CONCLUSION

In this study, two different composite conductive yarns were fabricated with the usage of ultrafine copper wires. They are presented as a flexible connection element for the e-textile

products in terms of the embroidery design. Composite conductive yarns are compatible with the embroidery process, which allows realizing a versatile textile-based circuit design. Traditional PDIP electronic components can be easily soldered on the conductive yarn. The ordinary yarn can be used as an isolator spacer, which makes the multiple layer design to be possible.

Since many alternative conductive core yarns have been produced with similar methods, the novelty of proposed yarn is in terms of choice of materials and design of fabrication. These novel yarns can be used for solder process. As a result, their potential applications will be versatile. That depends the kind of integrated electronic sensor/actuator/microcontroller. With the LEDs, we can make the textile screen. If we put some temperature sensors or gas sensors, they can be the PPE (personal protection equipment) for firefighters. With the help of accelerometer or gyroscope sensors, the health care garment can be invented by testing the of body position/posture of senior people.

However, all soldering processes which applied to the connection of the electronic components were craftwork and future studies should be involved to improve the mass production process. Even low-temperature soldering was applied to the samples, it is a quite high temperature for the textile-based materials. Thus, conductive glue or adhesive materials can be an alternative to overcome to soldering difficulties for textile-based materials.

Another limit of application is the size of lead of soldered electronic component. In this manuscript, package outline of component is PDIP. The distance between each lead is about 0.1 inch (2.54mm). The diameters of our yarns are 0.23 mm and 0.28mm, which are suitable for this distance between leads. However, some other kinds of package such as SOIC (Small Outline Integrated Circuit) require the 0.05 inch (1.27mm) distance between leads. In this case, our yarns cannot be employed. The thinner yarn should be developed for this kind of package.

Our future perspective will be focused on two topics: low temperature bonding technology such conductive adhesive and thinner conductive yarn design for miniaturized packages. All improvements should also be made to reach the traditional requirements of the consumers for an improved or at least equal end-user experience.

#### REFERENCES

- [1] V. KONCAR, *Smart Textiles and Their Applications*, 1st ed. New Delhi, India: Woodhead Publishing, 2016.
- [2] J. Hayward, *E-Textiles and Smart Clothing 2020-2030: Technologies, Markets and Players*. Cambridge, U.K.: IDTechEx, Apr. 2020.
- [3] *Textiles and Textile Products—Smart (Intelligent) Textiles—Definitions, Categorisation, Applications and standardization needs*, document ISO/PRF TR 23383, 2010.
- [4] R. R. Bonaldi, "Electronics used in high-performance apparel-Part 1/2," in *High-Performance Apparel*, J. McLoughlin and T. Sabir, Eds. New Delhi, India: Woodhead, 2018, pp. 245–284.
- [5] E. Ismar, S. K. Bahadir, F. Kalaoglu, and V. Koncar, "Futuristic clothes: Electronic textiles and wearable technologies," *Global Challenges*, vol. 4, no. 7, Jul. 2020, Art. no. 1900092, doi: 10.1002/gch2.201900092.

- [6] S. Varnait-Žuravliova, "Assessment of Electrical Characteristics of Conductive Woven Fabrics," *Am. J. Mech. Ind. Eng.*, vol. 1, no. 3, p. 38, Oct. 2016. [Online]. Available: <http://article.sciencepublishinggroup.org/html/10.11648/j.ajmie.20160103.12.html>
- [7] A. Ankhili, X. Tao, C. Cochrane, V. Koncar, D. Coulon, and J.-M. Tarlet, "Ambulatory evaluation of ECG signals obtained using washable textile-based electrodes made with chemically modified PEDOT:PSS," *Sensors*, vol. 19, no. 2, p. 416, Jan. 2019, doi: [10.3390/s19020416](https://doi.org/10.3390/s19020416).
- [8] J. Xie, M. Miao, and Y. Jia, "Mechanism of electrical conductivity in metallic fiber-based yarns," *Autex Res. J.*, vol. 20, no. 1, pp. 63–68, Mar. 2020, doi: [10.2478/aut-2019-0008](https://doi.org/10.2478/aut-2019-0008).
- [9] E. Ismar and A. S. Sarac, "Carbon Nanomaterials: Carbon Nanotubes, Graphene, and Carbon Nanofibers," in *Proc. Nanotechnol. Aerosp. Struct. Mech.*, 2019, pp. 1–33.
- [10] S. J. Pomfret, P. N. Adams, N. P. Comfort, and A. P. Monkman, "Advances in processing routes for conductive polyaniline fibres," *Synth. Met.*, vol. 101, no. 1, pp. 724–725, May 1999, doi: [10.1016/S0379-6779\(98\)01220-X](https://doi.org/10.1016/S0379-6779(98)01220-X).
- [11] C. Cochrane, V. Koncar, M. Lewandowski, and C. Dufour, "Design and development of a flexible strain sensor for textile structures based on a conductive polymer composite," *Sensors*, vol. 7, no. 4, pp. 473–492, Apr. 2007.
- [12] B. Kim, V. Koncar, E. Devaux, C. Dufour, and P. Viallier, "Electrical and morphological properties of PP and PET conductive polymer fibers," *Synth. Met.*, vol. 146, no. 2, pp. 167–174, Oct. 2004, doi: [10.1016/j.synthmet.2004.06.023](https://doi.org/10.1016/j.synthmet.2004.06.023).
- [13] Z. Hua, Y. Liu, G. Yao, L. Wang, J. Ma, and L. Liang, "Preparation and characterization of nickel-coated carbon fibers by electroplating," *J. Mater. Eng. Perform.*, vol. 21, no. 3, pp. 324–330, Mar. 2012, doi: [10.1007/s11665-011-9958-4](https://doi.org/10.1007/s11665-011-9958-4).
- [14] L. Capineri, "Resistive sensors with smart textiles for wearable technology: From fabrication processes to integration with electronics," *Procedia Eng.*, vol. 87, pp. 724–727, 2014, doi: [10.1016/j.proeng.2014.11.748](https://doi.org/10.1016/j.proeng.2014.11.748).
- [15] G. F. Eichinger, K. Baumann, T. Martin, and M. Jones, "Using a PCB layout tool to create embroidered circuits," in *Proc. 11th IEEE Int. Symp. Wearable Comput.*, Oct. 2007, pp. 105–106, doi: [10.1109/ISWC.2007.4373789](https://doi.org/10.1109/ISWC.2007.4373789).
- [16] Z. Wang, L. Zhang, Y. Bayram, and J. L. Volakis, "Embroidered conductive fibers on polymer composite for conformal antennas," *IEEE Trans. Antennas Propag.*, vol. 60, no. 9, pp. 4141–4147, Sep. 2012, doi: [10.1109/TAP.2012.6206307](https://doi.org/10.1109/TAP.2012.6206307).
- [17] L. Ukkonen, L. Sydanheimo, and Y. Rahmat-Samii, "Sewed textile RFID tag and sensor antennas for on-body use," in *Proc. 6th Eur. Conf. Antennas Propag. (EUCAP)*, Mar. 2012, pp. 3450–3454, doi: [10.1109/EuCAP.2012.6206307](https://doi.org/10.1109/EuCAP.2012.6206307).
- [18] R. Paradiso, G. Loriga, N. Taccini, A. Gemignani, and B. Ghelarducci, "WEALTHY-a wearable healthcare system: New frontier on e-textile," *J. Telecommun. Inf. Technol.*, pp. 105–113, 2005.
- [19] E. Ismar, S. U. Zaman, X. Tao, C. Cochrane, and V. Koncar, "Effect of water and chemical stresses on the silver coated polyamide yarns," *Fibers Polym.*, vol. 20, no. 12, pp. 2604–2610, Dec. 2019, doi: [10.1007/s12221-019-9266-4](https://doi.org/10.1007/s12221-019-9266-4).
- [20] E. R. Post, M. Orth, P. R. Russo, and N. Gershenfeld, "E-broidery: Design and fabrication of textile-based computing," *IBM Syst. J.*, vol. 39, nos. 3–4, pp. 840–860, 2000, doi: [10.1147/sj.393.0840](https://doi.org/10.1147/sj.393.0840).
- [21] D. Tyler, A. Mitchell, and S. Gill, "Recent advances in garment manufacturing technology: Joining techniques, 3D body scanning and garment design," in *The Global Textile and Clothing Industry*, R. Shishoo, Ed. New Delhi, India: Woodhead, 2012, pp. 131–170.
- [22] S. K. Bahadır, F. Kalaoğlu, and S. Jevánik, "The use of hot air welding technologies for manufacturing e-textile transmission lines," *Fibers Polym.*, vol. 16, no. 6, pp. 1384–1394, Jun. 2015, doi: [10.1007/s12221-015-1384-z](https://doi.org/10.1007/s12221-015-1384-z).
- [23] O. T. Ikkala, "Counter-ion induced processibility of polyaniline: Conducting melt processible polymer blends," *Synth. Met.*, vol. 69, no. 1, pp. 97–100, Mar. 1995, doi: [10.1016/0379-6779\(94\)02376-A](https://doi.org/10.1016/0379-6779(94)02376-A).
- [24] L. W. Shacklette, C. C. Han, and M. H. Luly, "Polyaniline blends in thermoplastics," *Synth. Met.*, vol. 57, no. 1, pp. 353–357, Apr. 1993, doi: [10.1016/0379-6779\(93\)90471-8](https://doi.org/10.1016/0379-6779(93)90471-8).
- [25] I. Locher and G. Tröster, "Enabling technologies for electrical circuits on a woven monofilament hybrid fabric," *Textile Res. J.*, vol. 78, no. 7, pp. 583–594, Jul. 2008, doi: [10.1177/0040517507081314](https://doi.org/10.1177/0040517507081314).
- [26] H. C. Chen, J. H. Lin, and K. C. Lee, "Electromagnetic shielding effectiveness of Copper/Stainless Steel/Polyamide fiber Co-Woven-Knitted fabric reinforced polypropylene composites," *J. Reinforced Plastics Compos.*, vol. 27, no. 2, pp. 187–204, Jan. 2008, doi: [10.1177/0731684407082628](https://doi.org/10.1177/0731684407082628).
- [27] K. Lai, R.-J. Sun, M.-Y. Chen, H. Wu, and A.-X. Zha, "Electromagnetic shielding effectiveness of fabrics with metallized polyester filaments," *Textile Res. J.*, vol. 77, no. 4, pp. 242–246, Apr. 2007, doi: [10.1177/0040517507074033](https://doi.org/10.1177/0040517507074033).
- [28] A. J. Uddin, "Novel technical textile yarns," in *Technical Textile Yarns*. New Delhi, India: Woodhead, 2010, pp. 259–297.
- [29] A. Bedeloglu, N. Sunter, and Y. Bozkurt, "Manufacturing and properties of yarns containing metal wires," *Mater. Manuf. Processes*, vol. 26, no. 11, pp. 1378–1382, Nov. 2011, doi: [10.1080/10426914.2011.577878](https://doi.org/10.1080/10426914.2011.577878).
- [30] S. Vassiliadis, Ed., *Electronics and Computing in Textiles*. Bookboon, 2012. [Online]. Available: <https://bookboon.com/en/electronics-and-computing-in-textiles-ebook>
- [31] S. Kursun-Bahadır, V. Koncar, F. Kalaoğlu, I. Cristian, and S. Thomassey, "Assessing the signal quality of an ultrasonic sensor on different conductive yarns used as transmission lines," *Fibres Text. East. Eur.*, vol. 5, no. 88, pp. 75–81, 2011.
- [32] S. Choi and Z. Jiang, "A novel wearable sensor device with conductive fabric and PVDF film for monitoring cardiorespiratory signals," *Sens. Actuators A, Phys.*, vol. 128, no. 2, pp. 317–326, Apr. 2006, doi: [10.1016/j.sna.2006.02.012](https://doi.org/10.1016/j.sna.2006.02.012).
- [33] C. Kallmayer, R. Pisarek, A. Neudeck, S. Cichos, S. Gimpel, R. Aschenbrenner, and H. Reichl, "New assembly technologies for textile transporter systems," in *Proc. 53rd Electron. Compon. Technol. Conf.*, 2003, pp. 1123–1126, doi: [10.1109/ECTC.2003.1216432](https://doi.org/10.1109/ECTC.2003.1216432).
- [34] I. Locher and G. Tröster, "Fundamental building blocks for circuits on textiles," *IEEE Trans. Adv. Packag.*, vol. 30, no. 3, pp. 541–550, Aug. 2007, doi: [10.1109/TADVP.2007.898636](https://doi.org/10.1109/TADVP.2007.898636).
- [35] T. Linz, M. von Krshiwoblozki, and H. Walter, "Novel packaging technology for body sensor networks based on adhesive bonding a low cost, mass producible and high reliability solution," in *Proc. Int. Conf. Body Sensor Netw.*, Jun. 2010, pp. 308–314, doi: [10.1109/BSN.2010.56](https://doi.org/10.1109/BSN.2010.56).
- [36] *Contacting electronics to fabric circuits with nonconductive adhesive bonding: The Journal of The Textile Institute*. Accessed: Feb. 21, 2020. [Online]. Available: <https://www.tandfonline.com/doi/abs/10.1080/00405000.2012.664867>
- [37] E. P. Simon, C. Kallmayer, R. Aschenbrenner, and K.-D. Lang, "Novel approach for integrating electronics into textiles at room temperature using a force-fit interconnection," in *Proc. 18th Eur. Microelectron. Packag. Conf.*, Sep. 2011, pp. 1–7.
- [38] T. Linz, E. Simon, and H. Walter, "Fundamental analysis of embroidered contacts for electronics in textiles," in *Proc. 3rd Electron. Syst. Integr. Technol. Conf.*, Sep. 2010, pp. 1–5, doi: [10.1109/ESTC.2010.5642823](https://doi.org/10.1109/ESTC.2010.5642823).
- [39] T. Linz, C. Kallmayer, R. Aschenbrenner, and H. Reichl, "Embroidering electrical interconnects with conductive yarn for the integration of flexible electronic modules into fabric," in *Proc. 9th IEEE Int. Symp. Wearable Comput.*, 2010, pp. 86–89, doi: [10.1109/ISWC.2005.19](https://doi.org/10.1109/ISWC.2005.19).
- [40] L. Buechley and M. Eisenberg, "Fabric PCBs, electronic sequins, and socket buttons: Techniques for e-textile craft," *Pers. Ubiquitous Comput.*, vol. 13, no. 2, pp. 133–150, Feb. 2009, doi: [10.1007/s00779-007-0181-0](https://doi.org/10.1007/s00779-007-0181-0).
- [41] X. Tao, V. Koncar, T.-H. Huang, C.-L. Shen, Y.-C. Ko, and G.-T. Jou, "How to make reliable, washable, and wearable textronic devices," *Sensors*, vol. 17, no. 4, p. 673, Mar. 2017, doi: [10.3390/s17040673](https://doi.org/10.3390/s17040673).
- [42] X. Tao, T.-H. Huang, C.-L. Shen, Y.-C. Ko, G.-T. Jou, and V. Koncar, "Bluetooth low energy-based washable wearable activity motion and electrocardiogram textronic monitoring and communicating system," *Adv. Mater. Technol.*, vol. 3, no. 10, Oct. 2018, Art. no. 1700309, doi: [10.1002/admt.201700309](https://doi.org/10.1002/admt.201700309).



**EZGI ISMAR** received the Ph.D. degree in nanoscience and nanoengineering from Istanbul Technical University (ITU), in 2019. In 2013, she was a Research Assistant with ITU. She is currently a Postdoctoral Researcher with the GEM-TEX Laboratory, University of Lille. She has several publications on these topics. Her current research interests include carbon nanofibers starting from their polymeric precursor, oxidation, and end-product properties.



**XUYUAN TAO** was born in Shanghai, China, in 1981. He received the Ph.D. degree in automatics from the Lille University of Science and Technology, Villeneuve d'Ascq, France, in 2010. Since 2011, he has been an Associate Professor with the ENSAIT, Textile Engineering Institute, Roubaix, France. His research interests include multifunctional and intelligent textiles, flexible sensors and actuators, smart textile structures, human-machine interface, and virtual textile.



**FRANÇOIS DASSONVILLE** was born in France, in 1972. He has been a Laboratory Technician with ENSAIT since 2001. He is currently assists Professors and the Ph.D. students in garment design, embroidery, and smart-textiles. He is the coauthor of nine publications. His research interests include multifunctional and intelligent textiles and human-machine interface.



**FRANÇOIS RAULT** received the Ph.D. degree in sciences and technology from the Université de Valenciennes et du Hainaut Cambrésis, in 2008, with RDT works performed in the development of multifunctional textile structures.

He was a Textile Engineer with ENSAIT in 2004. He has been an Assistant Professor with the Ecole Nationale Supérieure des Arts et Industries Textile (ENSAIT), French Textile Engineering Institute, Roubaix, France, since 2010. He is currently a member with the Multifunctional Textiles and Processes (MTP) Group, GEMTEX Laboratory. He develops functional fibers by melt spinning and innovative structures by various textile processes. He possesses strong experience in research and innovation in the field of smart (especially for energy harvesting, wireless communication, and data transfer) and multifunctional textiles. He worked and managed research activities in European and French project. He has authored or coauthored over 20 scientific publications, or book chapters, in international peer-reviewed journals.



**CÉDRIC COCHRANE** received the Ph.D. degree and the Habilitation à diriger des Recherches (HDR) degree in automatic (Highest University Diploma) from the University of Lille, in 2007 and 2018, respectively.

He is currently an Associate Professor with the Ecole Nationale Supérieure des Arts et Industries Textile, Roubaix, France, where he conducts research with the GEMTEX Laboratory. He possesses strong experience in research and innovation in the field of smart and multifunctional textiles. He has participated in many national and European projects focused on the design of mechanical sensors and electrodes, design of actuators (color change or light-emitting textile structure), and energy harvesting textile. He has authored or coauthored over 45 scientific publications or book chapters in international peer-reviewed journals. His research interests include reliability of the systems (washability for instance) and especially interconnection, networks, wireless communication, and data transfer are also investigated.

• • •