



**HAL**  
open science

## **Design of dry electrodes and impedance variations across different electrostimulation modalities**

Zuhaib Hassan, Xuyuan Tao, Cédric Cochrane, Vladan Koncar, E. Kashita, M. Fatima

### ► **To cite this version:**

Zuhaib Hassan, Xuyuan Tao, Cédric Cochrane, Vladan Koncar, E. Kashita, et al.. Design of dry electrodes and impedance variations across different electrostimulation modalities. Journal of Industrial Textiles, 2025, J. Ind. Text., 55, pp.1-45. <10.1177/15280837251346787>. <hal-05291527>

**HAL Id: hal-05291527**

**<https://lilloa.hal.science/hal-05291527v1>**

Submitted on 1 Oct 2025

**HAL** is a multi-disciplinary open access archive for the deposit and dissemination of scientific research documents, whether they are published or not. The documents may come from teaching and research institutions in France or abroad, or from public or private research centers.

L'archive ouverte pluridisciplinaire **HAL**, est destinée au dépôt et à la diffusion de documents scientifiques de niveau recherche, publiés ou non, émanant des établissements d'enseignement et de recherche français ou étrangers, des laboratoires publics ou privés.



Distributed under a Creative Commons CC BY-ND 4.0 - Attribution - No Derivative Works - International License

# Design of dry electrodes and impedance variations across different electrostimulation modalities

Volume 55: 1–45

© The Author(s) 2025

Article reuse guidelines:

[sagepub.com/journals-permissions](https://sagepub.com/journals-permissions)

DOI: 10.1177/15280837251346787

[journals.sagepub.com/home/jit](https://journals.sagepub.com/home/jit)

Zuhaib Hassan<sup>1</sup> , Xuyuan Tao<sup>1</sup>, Cedric Cochrane<sup>1</sup>,  
Vladan Koncar<sup>1</sup>, Eman Kashita<sup>2</sup> and Mahvish Fatima<sup>2</sup>

## Abstract

In electrostimulation applications, the role of dry-textile electrode is significant as compared to customary electrodes. It has vast demand due to their flexibility, breathability and its coherent integration to wearable medical devices. The use of electrostimulation to enhance the muscular structure and function is not a new idea; however, the introduction of dry textile electrodes can enhance the efficiency of the process. The review explores the different types of electrodes, mainly dry textile electrodes, its fabrication and performance across different modalities. The main focus includes the role of impedance across different electrode characterization, parameters of skin-electrodes contact point impedance and the operating devices with their operating system. A comprehensive review has been compiled to analyze various types of textile electrodes to determine their efficacy in different therapeutic modalities. The results suggest that different types of electrodes work different in various kind of modalities. It also concludes that sustainable conductive textile electrodes are considered a novel approach that can replace traditional metal or graphite electrodes. Moreover, it also suggests that the three-lead method provide the best way to evaluate the impedance across the electrode,

<sup>1</sup>ENSAIT, GEMTEX–Laboratoire de Génie et Matériaux Textiles, University of Lille, Lille, France.

<sup>2</sup>Department of Physics, College of Science, Qassim University, Buraydah, Saudi Arabia

## Corresponding author:

Zuhaib Hassan, ENSAIT, GEMTEX–Laboratoire de Génie et Matériaux Textiles, University of Lille, Lille 59056, France.

Email: [zuhaib.hassan@ensait.fr](mailto:zuhaib.hassan@ensait.fr)



Creative Commons Non Commercial CC BY-NC: This article is distributed under the terms of the Creative Commons Attribution-NonCommercial 4.0 License (<https://creativecommons.org/licenses/by-nc/4.0/>) which permits non-commercial use,

reproduction and distribution of the work without further permission provided the original work is attributed as specified on the SAGE and Open Access pages (<https://us.sagepub.com/en-us/nam/open-access-at-sage>).

excluding all remaining symmetric impedance of body. This review also highlights the sustainability and biocompatibility of dry textile electrodes and their potential to improve the patient's comfort in electrostimulation therapies.

### **Keywords**

Rehabilitation, electrical stimulation, textile electrodes, bioelectrical signals, skin-to-electrode impedance, dry textile electrodes, electrostimulation therapy, biocompatible, central nervous system, Functional Electrical Stimulation (FES)

## **Introduction**

Any kind of brain contusion, trauma, disease and health disorder can lead to the dysfunctionality of sensory-motor neurons. The intensity and range of wound always influence the area which would be affected such as tetraplegia would be the outcome of cervical injury, paraplegia could be the result of thoracic trauma and cerebral palsy could be the reason of brain contusion. These disabilities directly impact daily life activities of the affected person and may lead to mental trauma as well.<sup>1</sup> Many electrostimulation modalities help to rehabilitate the neuromuscular disorders such as Functional Electrical Stimulation (FES), Transcutaneous Electrical Nerve Stimulation (TENS), and Neuromuscular Electrical Stimulation (NMES) or electrical muscle stimulation (EMS). TENS and EMS practice are widely used to restore the motor functions with the help of physical therapy and to overcome the resulting disability.<sup>2</sup> Electrical stimulation can induce muscle contraction, hence used for neurorehabilitation, aiding in the treatment of voluntary motor neurons.<sup>3</sup> Different types of electrodes promote the efficiency of electrical stimulation. Juxtaposed to customary devices, usually composed of hard substances, sensors which are made of soft material and of hydrogel nature can give off high-grade performance in a long run. They can also be used in the monitoring of biological signals with the lowest contact with skin, having less impedance and an interface which has a moisture content in it. However, these electrodes present limitations, such as short lifespan, risk of skin irritation, and dependency on external gels or adhesives.<sup>4</sup> Moreover, metal electrodes (dry electrodes) are usually costly, rigid, less efficient and susceptible to the products of toxic metals, resulting from stimulation.<sup>5</sup> The effectiveness and solace of neuromuscular electrical stimulation (NMES) are heavily influenced by the type of electrodes used. As customary hydrogel electrodes which are self-adhesive are effective, they also have drawbacks related to wearability, compatibility with skin, and its reuse capability. This observation of textile electrode which were integrated with garments for electrostimulation explains its potential for rehabilitative applications in patients having neurological conditions like stroke, multiple sclerosis (MS), and spinal cord injury (SCI). Furthermore, dry textile electrodes have emerged as an innovative alternative, offering advantages like reusability, biocompatibility, flexibility, and enhanced comfort for long-term applications.<sup>6</sup> Dry textile electrodes are generally composed of conductive fibers or coatings<sup>7</sup> incorporating conductive polymers and materials into the structure of textile during different types of stages, such as during the manufacturing of fiber, spinning of

yarn, or at the stage of fabric creation.<sup>8</sup> The usability of electrodes of dry textile subjected to their performance in allowing current to interact with the interface of skin of human. Various factors, including sheet resistance, electrode resistance, fabric resistance, and skin to electrode impedance, affect the electrostimulation process.<sup>9</sup> The currents flowing in the fabric are electrons, whereas ions movements make the currents for human body. The impedance between human body and fabric's out of plane direction is influenced by many factors and it is beyond the resistance of material of electrode.<sup>10</sup> Key considerations include the fibre used in the fabric (internal inherent impedance of the fibre), conductive material used as coating over the fabric (silver, copper, or carbon-based, etc.), method of coating (dip coating, spray coating, or paste, etc.), and environmental factors (moisture, temperature, and pressure, etc.).<sup>11</sup> Textile electrodes encounter severe challenges in taking biomedical signals, as well as concerns like maintaining balance linking human wearer comfort, noise interference, pressure on skin contact point, and making sure precise measurement of electrochemical characteristics like alternating current impedance (ACI), static impedance (SI) and polarization voltage (PV).<sup>12</sup> Moreover, during the electrostimulation process with dry textile electrodes; impedance may vary in different types of electrostimulation modalities. These modalities enlist neuromuscular electrical stimulation (NMES), electrical muscle stimulation (EMS) and functional electrical stimulation (FES). Various types of ES give off a large range of diversified electrical pulses and current to the skin and to underlying skin tissues at a painful anatomical target, to relieve pain and enhance function in a way that is safer and better compatible with drugs.<sup>13</sup>

Secondly, there is lack of knowledge for the selection of suitable method or model to analyse the impedance of skin electrode with dry textile electrode in conformance to the electrostimulation modalities. Usually through two electrochemical valuation approaches: the first is direct detection and the second one is the method of reference detection.<sup>14</sup>

The former direct method, refers to measuring biophysical response responses (such as impedance, voltage, or current) accepts that skin tissue impedance is comparatively low, about 150  $\Omega$ . This method includes employing two electrodes directly on the skin's surface.<sup>12</sup> Moreover, there is another reference detection method which use two reference electrodes to compare signal changes at the stimulation site. However, Vojkan Mihjlovic used direct method to investigate the impedance between skin-electrode contact and dry electrode and also the skin behind the ear and observed that the pressure at contact point significantly influenced the skin-electrode contact impedance.<sup>15</sup> Antonio Lanata used the same strategy to detect the efficiency of textile electrodes at the digit end<sup>16</sup> and Dilpreet Buxi also used this method to analyse skin-electrode impedance.<sup>17</sup> Dry textile electrodes offer significant applicability for enhancing flexibility, comfort, biocompatibility and reusability in electrotherapy devices; however, the challenges persist in optimizing their impedance efficiencies for various electrostimulation therapies. Different types of textile electrodes behave differently in different types of electrostimulation modalities. The variability in electrode performance due to manufacturing material, design and fabrication method highlights the absence of standardized manufacturing process. The lack of knowledge about the standardized design, leads to unpredictability in the performance of electrode and incompatibility with previous electrostimulation modalities.<sup>18</sup>

In present review at first a detailed discussion provided on dry textile electrode structures and their impact on impedance characteristics. Types of dry textile electrodes,

their fabrication method, their impedance with different modalities for electrical stimulation will also be discussed. The review also covers the aspect of designing dry textile electrodes for different modalities with optimized impedance properties. It also emphasizes on the pattern of standardized protocol and design for the electrodes of dry textile, causing variety in the efficiency of electrode performance and its compatibility and with previous existing modalities for electrostimulation.<sup>19</sup> Additionally, several factors are present which compel to create the skin contact impedance, during electrostimulation such as types of devices, environmental factors (moisture, sweat, temperature, noise), skin to electrode interface, skin and inside the body muscles, impedance involve due to textile electrode specification and also due to the wear and tear of electrodes during service will also be monitored. Another important research gap will be highlighted to understand how different dry textile electrode impact impedance in various modalities such as in NMES, FES, and EMS applications. In addition, the role of various impedance models such as one time constant, two time constant, Cole Cole method, two, three and four-lead will also be studied. The role of impedance model structure will help to understand the skin-electrode contact impedance more efficiently. By addressing these gaps through a systematic way with standardized protocols will highlight the need for advanced practical application of dry textile electrode in electrostimulation therapies.

## Physiological systems and use of electrostimulation

The nervous system controls the muscular contraction, which drive all body movements in a body. Electrophysiology, a subfield of physiology, deals with channeling the single ion proteins at different frequencies to an entire organ for evaluating the changes in voltage and the produced electric current. The electrochemical activity of excitable cells generates bio-potential signals in various parts of body and can be measured. For instance, electrocardiograms (ECGs) measure the electrical activity of heart cells, electromyograms (EMG) measure muscle cell activity, and electroencephalograms (EEG) record brain activity. These signals provide valuable information for diagnosing, monitoring, and treating mild and serious health conditions.<sup>20</sup> It also has significance due to its usage in many therapies for muscle and nerves. This includes the transfer of electrical pulse to muscle or nerve for the purpose of activating excitable tissue with the help of electrodes.<sup>21</sup> Neuromuscular electrical stimulation (NMES) and electrical stimulation (ES) are therapies which use electrical impulses to excite the nerves, muscles and tissues in the body.

This technology has diverse medical and in therapeutic fields, ranging from managing the pain from any injury to the rehabilitation of the muscle of any organ.<sup>22</sup> Controlled electrical currents are delivered to specific areas of the body to elicit desired physiological responses. The term Functional Electrical Stimulation (FES) was first coined to develop a systematic procedure to excite the sensory-motor system artificially to deal with any injury related to brain and spinal cord which could lead to any potential disability. This method was also monopolized in the neural prostheses, and have practical application in the design of wearer medical stimulation systems to control the functioning of hand, arms and legs.<sup>23</sup> The devices using FES can directly support to perform impaired functions in individuals having CNS contusions. It can also promote the stimulation and reorganization of cortical excitability. Apart from this modality, ES is also used to act in CNS and on peripheral

nervous system. Electrical stimulation can act directly on the central nervous system or be applied to the peripheral nervous system. All these modalities are used to restore the functioning of sensory and motor nerves but the tested systems in patients are relatively simple.<sup>24</sup>

## **Types of electrodes used for electrostimulation**

### *Wet electrode*

Presence of gel layer in wet electrode making them suitable for the reduction of impedance between skin and electrode. Incorporation of gel in wet electrode, improves adhesion to the skin. To fill the gap between the scalp, conductive gel and saline solution is added. As, Ag/AgCl is present in wet electrode for better fitting with skin, they are preferred to be used electrophysiological activities. Wet electrode are also called Ag/AgCl wet electrodes. These wet electrodes are cheap and show enhanced electrical conductivity. Electrolyte gel applied to the skin to adhere electrode with skin is harmful but it makes hair and scalp dirty.<sup>25</sup> Degradation of wet electrodes occur when gel started drying up which makes signal transmission difficult. There are few limitations of using wet electrodes including skin preparation before adhesion and causing of skin irritation or allergy due to the application of gel. Mechanical peeling of the Wet electrodes might cause discomfort at the time of wearing and removing the electrode.<sup>26</sup> However, dead skin cells and oils (released from skin) build-up on the electrode lowering its quality in electrical conductivity and adhesion to the skin. To minimize these drawbacks, “dry-electrodes” could serve as a good candidate in clinical application to monitor health system because they are gel-free and long lasting.<sup>27</sup>

### *Semi dry*

Advancement in the technology give innovation and semi-dry electrodes are developed. These electrodes require a very little amount of electrolyte gel for conduction. Semi-dry electrodes highlight the advantages of wet and dry electrodes. As compared to the wet electrodes, transmission of bio-signals reliably better in semi-dry electrodes. Semi-dry electrodes are related to dry electrodes as their setup is fast and easy. Hence, improving quality of these semi-dry-electrode are using in EEG acquirement.<sup>28</sup>

### *Dry electrodes*

Dry electrodes facilitate bio-potential transmission, as application of dry electrode does not require any electrolyte gel for adhesion. Dry electrodes are advanced technology which provide high impedance value and skin preparation is not essential.<sup>29</sup> Dry electrode models have benign metallic tips, comb-like electrically conductive rubbers and conductive ink-coated elastic spikes transmitt the bio-electrical signals between electrode and scalp by uninterrupted resistive connector without any additional electrolytes. Certainly, due to easy to use, high comfort level, zero skin prep and cleaning of skin make dry electrodes much better option for practical application. One of the drawbacks to use dry

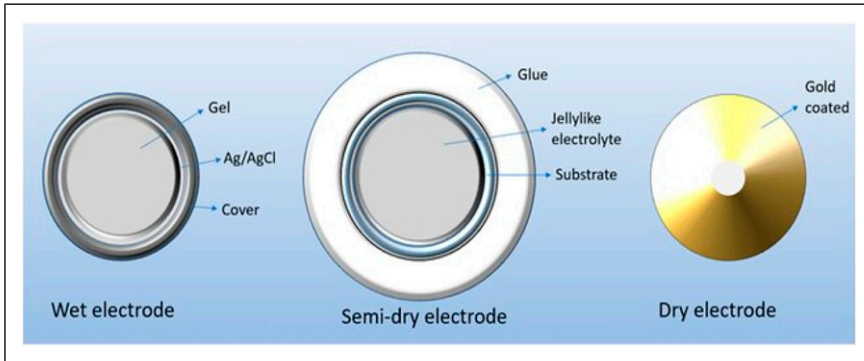

**Figure 1.** A visual form of wet electrode, semidry electrode, dry electrode.

electrode is that they show slightly higher impedance value as compared to wet electrode. Furthermore, due to absence of electrolyte, they do not adhere to skin properly and produce noise in EEG signals.<sup>25</sup> Dry electrodes, usually produced from inflexible materials, present encounters in achieving operational adhesion to the skin surface. A visual form of wet, semidry and dry electrode is shown in [Figure 1](#).

Reproduced from Liangtao Yang et al. (2022) [Insight into the Contact Impedance between the Electrode and the Skin Surface for Electrophysical Recordings] [ACS omega](#), under the terms of the Creative Commons CC BY NC ND 4.0 license.<sup>30</sup>

### *Dry textile electrodes*

Dry electrode performs as a polarizable electrode which is for its greater interaction capacitance. Normally, these electrodes connect to skin directly without the presence of any electrolyte gel and such electrodes are made up of metals.<sup>25</sup> Inflexible material making these electrodes inappropriate for adhesion to the skin and air trapped between electrode and skin which create dielectric layer that increase resistance. Flexible textile dry electrodes target to alter biopotential monitoring to a non-interfering procedure attained with the security of the everyday garments that we are now consuming.<sup>31</sup> Metals are used as a conductive material in fabrication of ECG electrodes,<sup>32</sup> fundamentally conductive polymers (ICPs),<sup>33</sup> and carbon-based materials.<sup>34</sup> These conductive materials and yarns through knitting, waeving and embroidery can be incorporated into fabrics through technical industrialization.<sup>35</sup> These wearable conductive textile electrodes deliver substitute, skin well-being and high resistance for consumers.<sup>36</sup> In Another study, dry textile electrodes and gel-based electrodes are tested on the basis of electrical signals. The skin–electrode connection contains diverse coatings of the skin and electrode that can be electrically demonstrated as corresponding circuits shown in [Figure 2](#) for dry and gel electrodes. Dry electrodes have marginally altered skin-impedance prototypes than gel electrodes initiated by accumulative air gaps and hairs consequential in both capacitive and resistive pairing with skin.<sup>25</sup>

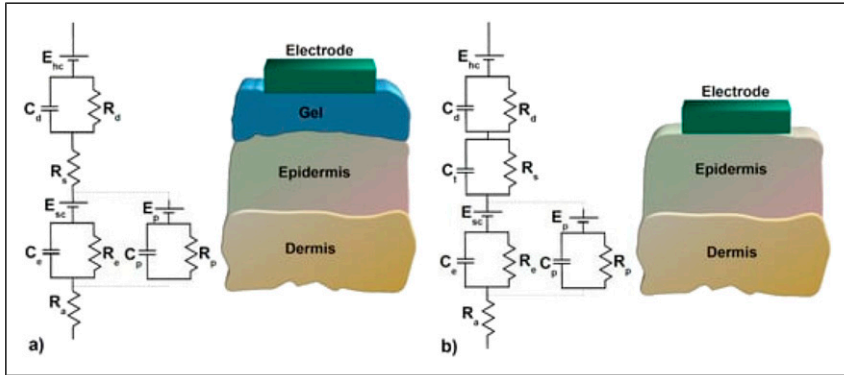

**Figure 2.** Equivalent circuit of skin–electrode interface for (a) traditional wet electrodes and (b) textile electrodes.<sup>145</sup> L.Beckmann Adapted from Beckmann et al. (2010) [Characterization of textile electrodes and conductors using standardized measurement setups], *Physiological Measurement*. Reproduced with permission from Copyright Clearance Center (license no. 1620533-1).<sup>30</sup>

## Fabrication techniques for dry textile electrode

Textile electrodes are included in “smart textile”, or electronic textile (e- textile) which is an emerging scaffold within the growing field of wearable electronics.<sup>37</sup> They can be produced by different techniques as listed below.

### *Metal deposition method to fabricate dry textile electrode*

Electrodes production of dry textile aimed for electrostimulation through metal deposition has been a focal point of recent research, aiming to develop flexible, durable, and efficient alternatives to traditional gel-based electrodes.<sup>38</sup> Metal deposition onto textile substrates is a key method for creating conductive pathways essential for electrostimulation. The metal deposition may be carried out by some physical methods or wet chemical processes. Common techniques include: **1)** spraying In-situ metallic particles deposition over fabric structure,<sup>39</sup> **2)** dip coating in solution **3)** electroless,<sup>40</sup> **4)** electroplating.<sup>41</sup>

In fact, metallization on textiles with conductive paints, conductive inks and laminating technique have some setbacks such as rigidity of material and weak air breathability. In some cases, thin metal wires are spun with yarn and then integrated with textiles. The material produced from this method is quite tough and challenging to carry hard metals against human body.<sup>42,43</sup> Hence, the metal nanoparticles deposition with solution techniques such as In-Situ deposition and electroless plating is good to maintain the electrical conductivity with flexibility. Azam et al., developed the electrically conductive cotton fabric-based electrodes of copper particles with the technique of In-Situ deposition. The preparation of samples was done by simple dipping in salt solution and then reduction. The trend depicts the immense deposition of copper particles by IN-Situ method by increasing dipping cycles. Second most common and suitable technique for making the

electrically conductive textile-based electrode is based on electroless plating. Electroless copper plating, a type of non-electrolytic method, is the deposition on fabric from solution and recommended by many researchers.<sup>44,45</sup> But an important step during this process is to opt the potential reducing agent. As, in previous method of electroless plating researchers have been applied for sputtering and vacuum deposition for the surface's sensitization, followed by silver plating on conductive substrate.<sup>46</sup> This method is quite effective to attain surface conductivity, however, achieving the volume conductivity through this substance is very challenging. Within existing techniques, electroless plating on solution sensitized fabrics is still far better option as it provides better volume conductivity, coherent property on metal deposition, durability, and applicability to the materials of complex shapes.<sup>47</sup> A study reported the electroless deposition of copper by catalytic redox reaction of metal ions and reduction agent (formaldehyde), which is dissolved in alkaline media at elevated temperature. However, this method possesses safety issues as the production of toxic gases during the process of electroplating, and proves to be ineffective at large scale industrial application. To solve this issue, researchers are trying to find the optimum way to exchange formaldehyde with other agents (reducing), which could combine with oxidation accelerators like nickel sulphate and sodium hypophosphite. Moreover, a few studies explain the traditional method in which palladium metal was used as an activator to start the process of electroless plating.<sup>48</sup> Currently, the rising cost of palladium makes it quite expensive for the plating process. Hence, there is always a need to find alternative ways which are more economical and quite dependent for activation process. Moreover, researcher used two-way process for copper plating, sensitization followed by activation prior to the plating stage. Hence, more research is required to establish more safer protocol to fabricate the copper in textiles.<sup>49</sup> To overcome this problem, Azam et al., introduces an innovative approach to fabricate the long lasting, fabric based, electrically conductive electrodes. He combined the In-Situ deposition and electroless plating step to gain synergic effect to depict the electrically conductive behavior as illustrated in Figure 3(a).<sup>50</sup> In their method, they forced out the step of sensitization and directly imparted copper and silver particles onto the fabric substrate. This deposition prepared the fabric for electro less plating. This approach highlights cost effective<sup>51</sup> and sustainable way of copper plating on the fabric of cotton. The procedure for metal electroless plating over the In-Situ deposited textile electrodes is showing in Figure 3(b).

### *Fabrication of dry textile electrode during weaving and knitting with conductive yarns*

Conductive tracks can also be produced by interlacement of electrically conductive yarns and threads to make weaved or knitted fabric structure; leads for wearable electrode systems. Woven fabrics are created by interlacing two yarns set which are arranged perpendicularly.<sup>52</sup> Conversely, knitting involves the use of needle to interconnect loops of yarn with each other. Owing to its traditional way, the whole garment can now be knitted on single machine. It also supports a major variety of filaments and different kinds of natural yarns, making it the most desired approach for the manufacturing of Meanwhile, knitting enables the processing of a wide variety of

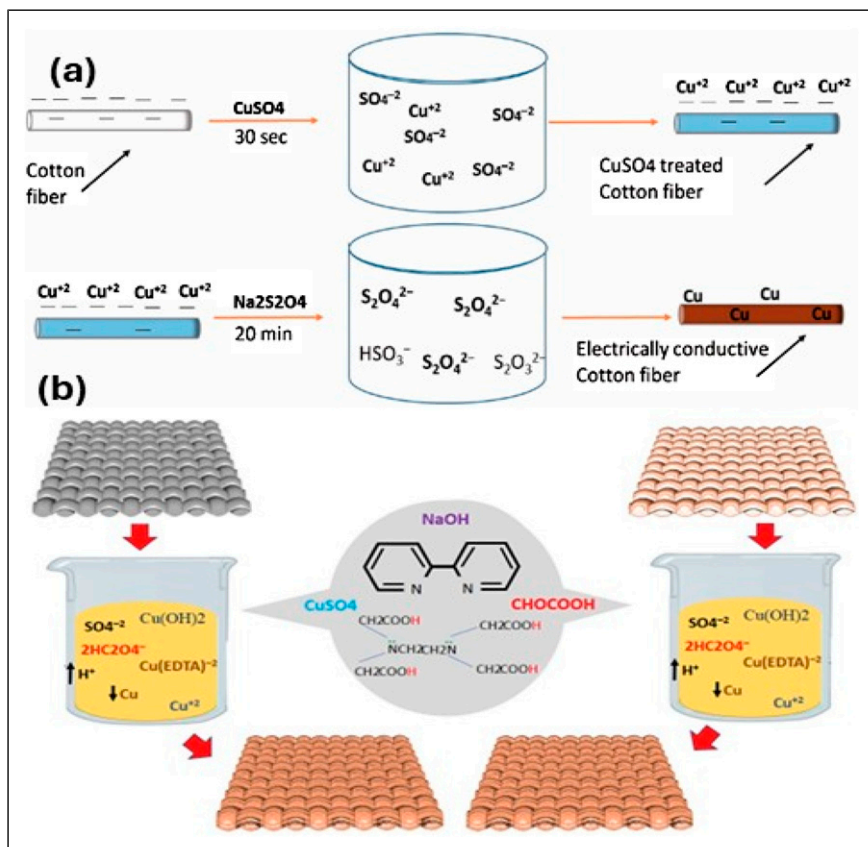

**Figure 3.** (a) Deposition of copper particles by In-Situ process<sup>50</sup> (b) Electroless copper plating to make the electrically conductive fabric-based electrodes (a) Reproduced from Azam Ali et al. (2017), [Copper coated multifunctional cotton fabrics]; published by [Journal of Industrial Textiles], Reproduced with permission from Copyright Clearance Center (license no.6050270772648),<sup>50</sup> (b) Reproduced from Azam Ali et al. (2020), [Copper electroless plating of cotton fabrics after surface activation with deposition of silver and copper nanoparticles]; published by [Journal of Physics and Chemistry of Solids], Reproduced with permission from Copyright Clearance Center (license no.6050270362617).<sup>51</sup>

natural yarns and filaments. For this reason, it has been considered the most suitable method for preparing discreet and skin-friendly garment.<sup>53</sup> Even with various benefits, knitted fabric tend to have various intermittent contacts points in the yarns, which may result in the inconsistency of electrical resistivity particularly under dynamic conditions. Even though the fluctuation in biopotential signals is not favorable as it can produce signal artifacts, yet these are recommended in the sensor devices.<sup>54</sup>

Most of the time conductive yarns in embroidery lie on the surface of the fabric, this technique is believed to enhance the contact between the electrode and skin. Hence, embroidery is considered an ideal type for prototyping textile electrode in garments. On

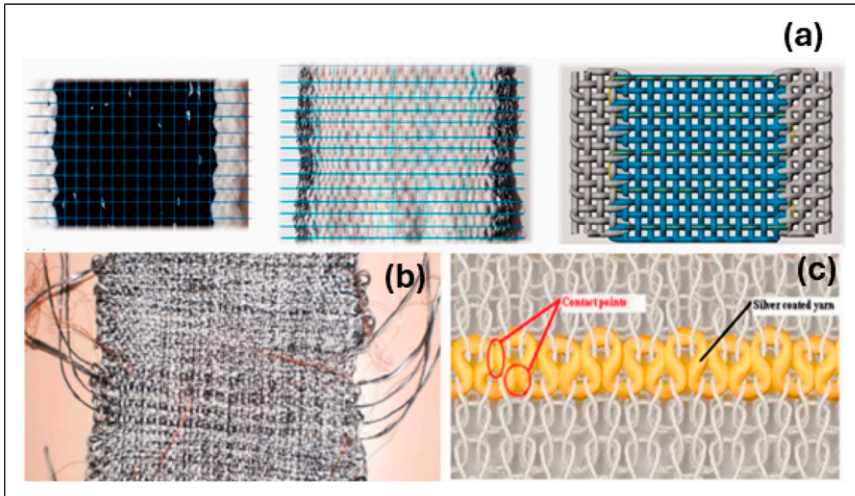

**Figure 4.** (a) The fabric design showing the interlacement of conductive yarn pattern in textile fabric, Fabric design showing the interlacement of conductive yarn in textile fabric (b) during knitting, (c) during weaving. (a) Reproduced from Yuanfang Zhao et al. (2022), [Development of customizable conductive thermal woven textile for ready-to-wear functional collections] published by [Textile Research Journal], Reproduced with permission from Copyright Clearance Center (license no.6050280192481),<sup>146</sup> (b) (c) Reproduced from Ana M Grancarić et al. (2017), [Conductive polymers for smart textile applications] published by [Journal of Industrial Textiles], Reproduced with permission from Copyright Clearance Center (license no.6050280478376).<sup>55</sup>

the other hand, knitting and weaving has a potential in large scale production of potentially preferred smart garment.<sup>55</sup> The fabrication of dry textile electrode during Weaving and knitting with conductive yarns is illustrated in Figure 4(a)–(c).

### *Fabrication of dry textile electrode with embroidery technique*

Embroidery is used to develop conductive patterns on fabrics which is a unique method in textile production and embellishment. Conductive fibers are used to create these patterns on fabric surfaces. Stitches are usually used to make these patterns on fabric surface to increase decoration. Knitted textiles offer skin well-being, low weight, and high elasticity for consumers.<sup>56</sup>

### *Fabrication of dry textile electrode by coating of conductive polymers*

Conduction depends on three things including conductive material, insulators and semi-conductors and these factors are not defined correctly. Conduction lies in mid of semi-conductor's conductivity.<sup>57</sup> Blending of insulating matrix, thermoplastic with conductive fillers produce extrinsically conductive polymers (ECPs), or conductive polymer composites (CPCs). Most common conductive fillers are three including carbon (carbon black (CB) and carbon nanotubes (CNTs)), metal powders and their compounds (indium tin

oxide (ITO) and aluminum zinc oxide (AZO)), and ICPs (PPV, PANI) to increase conduction of the material. ECPs have distinctive properties such as better electrical and thermal conductivity, corrosion resistance and good mechanical possessions. They are used as conductive and semi-conductive polymer fibers, corrosion resistant coverings, ESD materials, electronics, and solar accumulators. Their electrical conduction values are much lower than the conduction value of ICPs, ranging between  $10^{-5}$  and  $10^3 \text{ Scm}^{-1}$  subject to their presentations.<sup>58-61</sup> However, it is not essential to first generate electrically conductive Nano-fibers and then yield a non-woven textile to take benefit from the enormous surface capacity. It is easy and more effective to first produce non-woven textile with electrospinning and then add conductive filler on to it for conduction. This method would facilitate researcher to examine textile electrodes in bio-potential signals against Ag/AgCl electrodes.<sup>62</sup>

### *Fabrication of dry textile electrode with printing technique*

A widely use technique to create conductive prints on fabrics is ink-jet and screen printing. This technique prints various images on fabrics for conduction.<sup>63</sup> Few benefits of printing procedures comprise: (a) site-specific, restricted, and direct installation of conductive materials on complete roll-to-roll (R2R) manufactured textiles; (b) reduction in usage of toxic chemicals and printing inks; (c) capability for variation to both desktop scale R&D and profitable developed surroundings with the potential to be joint with or allow additional reduction of e-textile production expenses.<sup>64</sup> Screen printing on textile fabrics provide can provide greater quantities of ink associated to ink-jet printing. Consequently, screen printing necessitates less printing sequences to attain a constant conductive decoration on textile exteriors.<sup>65</sup> Another matter to be addressed in using screen printing is associated with contact and non-contact nature of the printings. Pressure application in screen printing on textile fabrics stimulates bond, diffusion of the ink to the substrate, and enables the development of connected designs. Similarly, non-contact ink-jet printing depend on the extent of the ink to accomplish the assimilation of consecutive ink precipitations and produce electrically-connected arrangements, which needs careful manufacturing of the ink dispersal and printing development, exclusively on irregular textiles where yarn-to-yarn spaces may be on the direction of tens of microns.<sup>66</sup> However, use of different electrode solution used on conductive materials can help in overcoming this issue. Many of them use silver ink to create the electrode, because of good electrical conductivity and ease of printing.<sup>67</sup> Metallic inks and conductive pastes can be created by consuming metallic nanoparticles, metallo-organic complexes, or metallic salts as precursors.<sup>68</sup> There are silver based metallic inks to be used on textile substrates but they are expensive and their curing temperature is high which should be lowered down to produce valuable results. This metallic ink can produce health risks when come in contact with skin.<sup>69</sup> Inkjet printing shows flexibility in design formation and existing materials marks its versatility for e-textile investigation. While screen printing due to the use larger amount of ink and less cycles ink printing, making it more reliable and cheaper source to be used in commercial industries.<sup>70</sup> To achieve conductive designs viscosity and curing temperature of ink to be used in printing is necessary along with surface properties as well including roughness of fabric and surface energy.<sup>71</sup> The surface texture, density, porosity, and

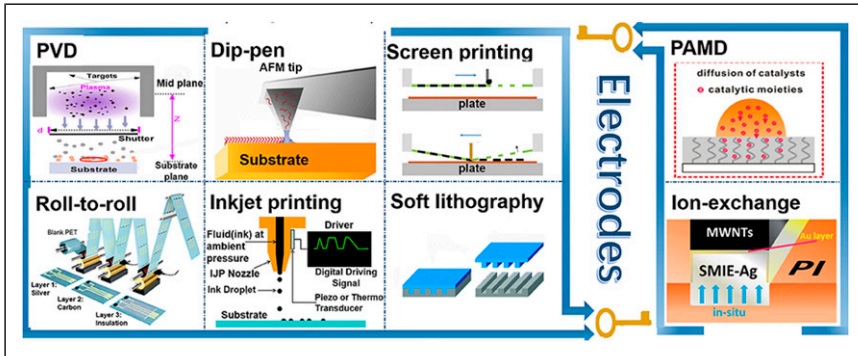

**Figure 5.** Different kind of printing techniques used for printing the dry textile electrodes Reproduced from Quanling Li et al. (2019), [Review of printed electrodes for flexible devices]; published by [Frontiers in materials] under the terms of the Creative Commons CC BY 4.0 license.<sup>147</sup>

thickness of nonwoven fabrics can be measured during manufacturing to attain expected outcomes which depend on diameter and inter-yarn distance. They are also inexpensive and quicker to construct, which makes them enhanced substrates on which to print.<sup>72</sup> Woven textiles are recognized as more flexible and breathable than nonwoven textiles making them easier to wear. Furthermore, it was recommended that the formation of a high surface energy boundary coatings on surface of the material can offer an anticipated substrate on which to print, while preserving the easy wear of the woven fabrics. The additional boundary layer is not projected to affect relief since it can also be reproduced on only the preferred areas, such as electrodes and their inter-connections.<sup>73</sup> For this purpose, poly (3,4-ethylenedioxythiophene)-poly (styrene sulfonate) (PEDOT: PSS)-based resolutions are observed as the most encouraging material to come into the marketplace, due to their elastic handling and long-lasting electrical conductivity.<sup>74</sup> Scatterings of graphene or CNTs can also be used in laser printing to generate conductive designs. The consequence of pre-treating the fabric to upsurge its printability was also revealed with ink-jet printing a hydrophobic film prior to application of GO solution. This helped to expand the steadiness of the conductive layer by three commands of magnitude associated with untreated coverings.<sup>75</sup> Various kind of printing techniques are illustrated in Figure 5.

## Role of controlled impedance against effective electrostimulation

During electrostimulation with dry textile electrode several types of impedances may involve. These impedances not only involved due to electrode alone but also due to other different reasons. Hence, to perform the effective electrostimulation process it is necessary to consider and study all possible impedances involved; which are directly or indirectly associated with dry textile electrode.<sup>76</sup> Impedances during effective electrostimulation relies on several factors which may be categorized into three main groups. 1). Impedance involves due to characteristics of dry textile electrode. (2) Impedance due to involve

parameters/factors between skin and electrode. (3) Impedance involved due to the electrostimulation devices, and operating parameters.

### *Impedances involved due to dry textile characteristics*

Different types of dry textile parameters, such as shape, size, thickness, physical state of textile electrode (wet, gel mixed, or complete dry), nature of conductive material (metallization, conductive polymers, metal wires or carbonized filler), physical shape or weave pattern may affect and play a certain role in skin electrode impedance during electrostimulation process.<sup>77</sup> In case of recommended electrodes (dry textile-based electrodes), resistance is usually due to the presence of sheet resistance within fabric. To assess a potential electrode, the characterization should be done on their functional performance. The most common characteristic either for the electrode structure or conducting material is the sheet resistance. Moreover, both sheet resistance and resistance are important consideration while engineering the conductive leads that combine various types of textile-electronics measurement devices.<sup>78</sup>

*Effect of condition of electrode (wet textile or dry textile) on impedance.* The textile-based electrodes exhibit distinct impedance characteristics in different state (wet textile or dry textile). Such as, in a recent study, three different compositions of electrodes (a) wet fabric electrodes (b) fabric electrodes covered with hydrogel and (c) dry fabric electrodes. The results showed that the wet electrodes showed least impedance than dry and gel electrodes. But there are number of disadvantages associated with wet electrodes such as maceration effect on skin, irritation and short life etc. As expected, dry fabric electrodes show high noise levels. Moreover, wet fabric electrodes demonstrate significantly lower noise levels, as compared to fabric-based electrodes with hydrogel coating. The comparative analysis depicts the impedance of skin electrode contact of wet, dry and gel electrodes described [Table 1](#). In fact, Skin naturally responds to any substance that comes into contact with it, such as the materials appear over the skin due to increased blood circulation over the skin's surface or changes occur due to perspiration. All these salts and contaminates eventually affect the skin-electrode impedance.<sup>79</sup>

One more study was conducted to investigate the effect and condition of textile-based electrode (wet or dry state) over the impedance. It was concluded that textile electrode exhibited higher impedance rather than hydrogel electrode. However, it was also observed that once fully saturated, the wet-textile based electrode showed decreased impedance across the entire frequency interval. The dry textile-based electrodes showed the reduction in impedance, 1 kHz, the average impedance decreased from 4.72 k $\Omega$  in the dry state to 0.95 k $\Omega$  in the wet state, showing the 40% lower impedance than that of hydrogel electrode which have the impedance of (1.57 k $\Omega$ ).<sup>80</sup> The impedance of different type of electrode are illustrated in [Figure 6](#).

*Effect of shape and size of electrode (wet textile or dry textile) on impedance.* Different shapes and sizes of dry textile electrodes also effect on final measurements of skin electrode impedance. In current time, researchers are working on the effect of different size of electrodes (developed with same conductive material) was checked for electrotherapy.

**Table 1.** The impedance of Skin-electrode with various types and sizes of dry textile-based electrodes.

Electrolyte type	Sizes diameter (mm)	Impedance	Respective graphical representation
<b>Dry Textile</b>	30 mm	>100kΩ	
	20 mm	>100kΩ	
	15 mm	>100kΩ	
	10 mm	>100kΩ	
	7 mm	>100kΩ	
<b>Wet Textile</b>	30 mm	~25kΩ	
	20 mm	~50kΩ	
	15 mm	~50kΩ	
	10 mm	~70kΩ	
	7 mm	~40kΩ	
<b>Gel Textile</b>	30 mm	~35kΩ	
	20 mm	~80kΩ	
	15 mm	>100kΩ	
	10 mm	>100kΩ	
	7 mm	>100kΩ	

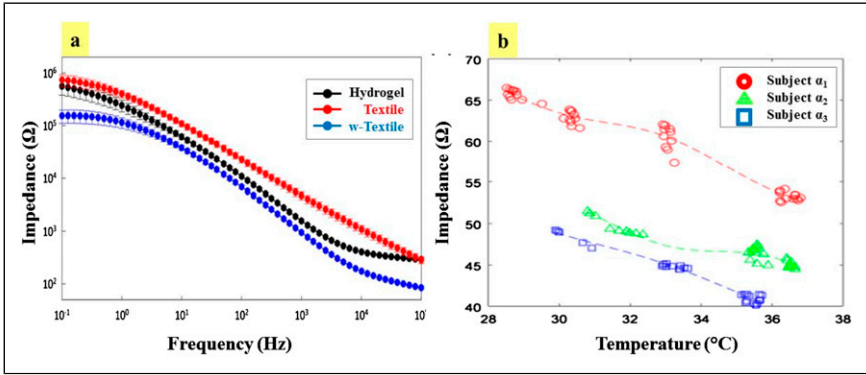

**Figure 6.** (a) The Impedance of different types (hydrogel, textile, and wet textile) electrode, studied on TA muscle of human<sup>80</sup> (a) Reproduced from Hui Zhou (2015), [Stimulating the Comfort of Textile Electrodes in Wearable Neuromuscular Electrical Stimulation], published by [Sensors] under the terms of the Creative Commons CC BY 4.0 license. (b) Impedance variation according to temperature. Reproduced from Hyung Wook Noh (2019), [Ratiometric Impedance Sensing of Fingers for Robust Identity Authentication]; published by [Scientific Reports] under the terms of the Creative Commons CC BY 4.0 license.<sup>148</sup>

The research was done for different range of sizes for electrostimulation and the results were obtained against the noise and for the impedance of skin-electrode contact. The primary results show that as the size of electrode decreases, the noise level was increasing.<sup>81</sup> Similarly, another case study described the involved impedances due to various shapes of dry textile-based electrodes. The knitted dry textile electrodes composed of polyamide yarns and silver at operating conditions of (voltages 10 mV and frequency 39 Hz) with sizes and shapes showed significant variation in impedances. However, when shapes were analyzed for electrodes within a single study, solely the electrodes which are ‘best are square shapes and operating at higher frequency’ (have low impedance) and ‘worst’ in circular shape (have high impedance). The impedance variation across different sizes of electrodes is explained in [Table 2](#).

*Effect of conductive material of electrode on impedance.* The conductive material of the electrode highly determines the rate of impedance for any kind and type of electrode. At present, researchers have been investigating the rate of impedance for different types of

**Table 2.** Overview of impedance against dry textile-based electrodes with sizes and shapes showed significant variation.

Measurement specification	Electrode shapes	Impedance	Ref
2W-Z, 50 μA, 85 Hz; on head	Square, 16 cm <sup>2</sup>	5.3 (3.1) kΩ	<sup>150</sup>
2W-Z, 10 mV, 1000 Hz; on lower leg	Rectangular, 24 cm <sup>2</sup>	1.57 (0.08) kΩ	<sup>13</sup>
3W-Z, 10 mV, 39 Hz; on forearm	Uneven or circular surface, 20.9 cm <sup>2</sup>	14.0 MΩ	<sup>19</sup>

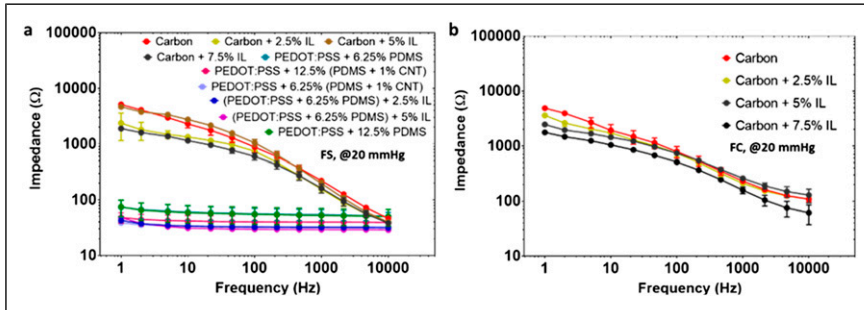

**Figure 7.** The agar-electrode impedance of textile-based electrodes. (a) Flat textile structure for different coating materials over frequency range of 1-10,000 Hz. (b) FC structure with various conductive coating materials in the frequency range of 1-10,000 Hz. Reproduced from Milad Alizadeh-Meghrazai et al. (2021), [Evaluation of dry textile electrodes for long-term electrocardiographic monitoring]; published by [BioMed Eng OnLine] under the terms of the Creative Commons CC BY 4.0 license.<sup>9</sup>

conductive materials on dry textile-based electrodes. Among them, flat textile electrodes composed of silver coating exhibited lower impedance as compared to carbon and PEDOT: PSS-contained coating, displaying a trend observed in earlier studies.<sup>9,82</sup> Additionally, more parameters of conductive materials such as coating of material and evenness of material also influence the rate of impedance. Dry textile-based electrodes containing carbon coatings displayed greater change in impedance than with the coating of PEDOT: PSS. Moreover, it was also concluded that the CNT coating or ionic liquid can also decrease the impedance of dry textile-based electrodes. CNT coatings were observed to enhance the electrical conductivity by creating the nanotubes bridges between isolated conductive domains, thereby improving electrical conductivity.<sup>50,83</sup> Dry textile-based electrodes with coating of carbon-contained displayed great impedance change as compared to PEDOT-PSS contained coatings as illustrated in Figure 7(a). It also showed a comparative analysis conductive materials over a frequency range Figure 7(b).

*Effect of physical shape or weave pattern of electrode on impedance.* To increase the flexibility and conformability of electrodes with body parts, knitted fabrics were used instead of loom-woven structures. Azam et al. conducted a study in which they silver and copper nanoparticles were deposited on knitted fabrics by wet chemical process, having potential use in electrotherapy. The efficiencies for conductive electrodes was tested for a few characteristics such as physiological comfort, electrical conductivity, antibacterial effectiveness, and durability. Their fabric-based electrodes were not only stretchable but also played a vital role in constant current delivery even body parts were moving. The electrodes were subjected the constant current through the TENS machine of electrotherapy. Figure 8(a) shows the flow of current through the electrodes, Figure 8(b) presents the prepared flexible metal coated electrodes. The constant current for the prolonged duration of time was given and was the constant output as shown in Figure 8(c). They also

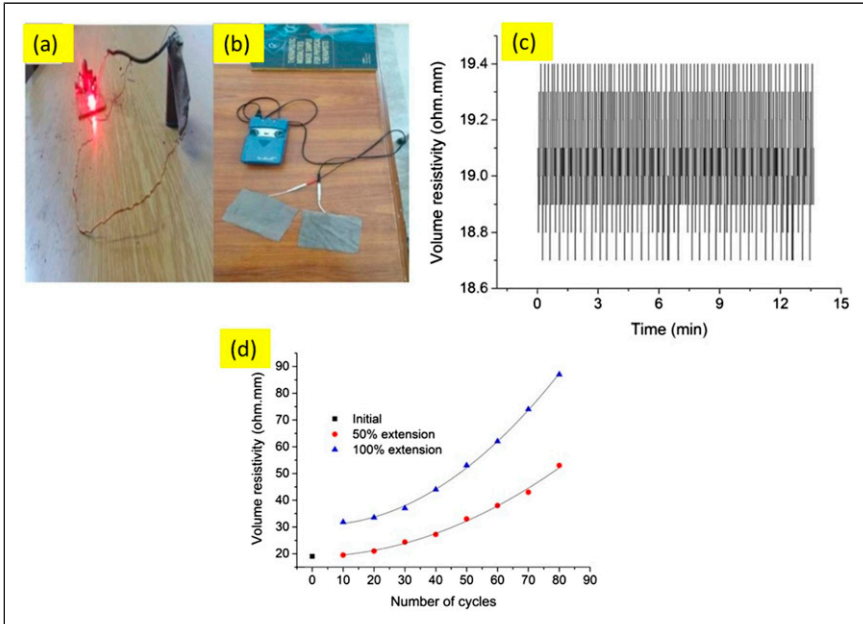

**Figure 8.** (a) Flow of current through the knitted fabric electrodes, (b) the prepared stretchable knitted electrodes. (c) Constant behavior of electrical resistivity over a prolonged duration of time, (d) electrical resistivity behavior against 50% and 100% stretch of conductive knitted electrodes, Reproduced from Azam Ali et al. (2018), [Utility of silver-coated fabrics as electrodes in electrotherapy applications]; published by [Journal of Applied Polymer Science] Reproduced with permission from Copyright Clearance Center (license no.6050440847942).<sup>84</sup>

subjected the various stretch and recovery cycles to the prepared electrodes and observed the drop in volume resistivity Figure 8(d).<sup>84</sup>

Moreover, the brief discussion over the type of impedance involved due to the different types of material of electrodes and their limitations are given in Table 3.

*Impedances involve due to the ageing of electrodes.* The insertion of array of electrode in the tissue of neurons can generate a response of inflammation, a reaction that can be intensify with continuous supply of electrical currents. Over time, the prolonged stimulation not only aggravate the biological response but also contribute to the degradation of material of the electrode, that can be amplified in the presence of inflammatory environment. The combination of deterioration of electrode and worse reaction of tissues pose serious risk to the long-term efficiency and reliability on the electrode for stimulation.<sup>85</sup> Sometimes electrical readings can also be changed significantly due to surface modification. The rigorous testing makes the abrasion on electrode sites, leading to the increase in surface area without changing the diameter. It can cause current leakage, increase in capacitance and reduction in impedance. Moreover, the coating of conductive materials like PEDOT or platinum black on the recording sites can significantly alternate the effectiveness of resistance, capacitance and impedance as well.<sup>86</sup> The material composition of electrode

**Table 3.** Electrodes specification, impedances involved and recommendations for effective electrostimulation.

Sr. no.	Material/ substrate/object name	Limitations with respect to the transmission of electrical signals or associated resistances.	Ref.
1	Self-adhesive	While using pre-gelled electrodes continuously, the gel dries out it can rapidly reduce the electrical conductivity.	151
2	Carbon rubber electrodes	Hard structures may have the sharp edges may start lifting, which can drastically raise the current density, resulting in an uneven current distribution.	152
3	Electrode gel	The air drying of gel could result in drastic rise current density, which results to irregular current circulation, in turn results in uneven distribution of current signals.	153
4	Electrodes sponges	To connect carbon rubber electrodes to the skin, sponges wet with tap water could be utilized and it is a suitable choice when utilizing large electrodes. It is important to ensure the sponges are properly dipped (neither excessively wet nor overly dry), and when they become dirty, they could be replaced.	154
5	Sizes of electrodes	By using smaller electrodes current density could be enhanced, and results in excitation less comfortable and increasing the risk of burns. It is important to ensure the size of electrodes adjustable with the relevant muscles, an average size electrode mostly use in the forearm, shoulder, and in calf. It is recommended to use larger electrodes larger muscles like the lumbar spine quadriceps and hamstrings. To ensure the greater distribution of current.	155
6	Electrodes polarity	The polarity of electrodes is severely affecting the resistance and transmission of proper signals. Selecting the appropriate size and polarity of electrode is important and should be based on target muscle properties. The polarity of electrodes is primarily determined by their sizes; larger electrodes tend to be more polar and could be adjusted on the area where they applied.	156
7	Electrodes positioning (Mono polar placement)	The cathode was placed on the motor neurons of objective muscle, while anode was placed on the muscle of objective, or directly on nerve that layout nerve supply. The waveform exhibits greater current distribution in both negative and positive direction, hence engineering a well-defined circuit.	157

(continued)

**Table 3.** (continued)

Sr. no.	Material/ substrate/object name	Limitations with respect to the transmission of electrical signals or associated resistances.	Ref.
8	Electrodes positioning (Bipolar electrode placement)	This position could be considered when the waveform generates even current distribution in both directions, during each pulse both electrodes are thought to be efficient, and both electrode experiences negative and positive phase. For the reduction of impedance for current distribution it is possible to align the electrodes in a parallel to the longitudinal direction of the muscle fiber.	158
9	Electrodes spacing	When electrodes are positioned near each other the current tend to travel closer to surface. The distribution of the current will be greater in case of wider spacing due to deep penetration, electrodes are typically positioned at a greater distance.	159
10	Dry textile electrodes	The most important electrodes are dry textile electrodes, because they can reduce the resistance in many ways as their flexibility allow them to adhere to the applied area. Hence, they can enhance the skin electrode contact. However, it lacks due self-adhesive system which limit the efficiency of these electrodes.	160

also plays an important role in determining the damage of anode under electrostimulation. platinum-iridium and platinum based electrodes demonstrated great durability, with no sign of degradation under electrostimulation. . In contrast, stainless steel exhibited the least resistance to corrosion, especially under direct current (DC) stimulation. The electrodes made from tungsten responded differently under DC due to the development of protective surface layer. Platinum's ability to maintain great level of current over time, can cause increase in temperature of the solution. Additionally, short intervals of stimulations can cause shift in the pH near electrode surface.<sup>87</sup> The impedance change due to stimulation is temporary, as the value of impedance returns back to ground readings after several hours of electrostimulation. This phenomenon explains the loss of cells from the surface of electrodes after every stimulation and also implies that electrical stimulation caused localized disruption in the phenomenon of cell adhesion.<sup>88</sup> A study by Green et al., explains the degradation of platinum- based surface area of electrodes. The platinum electrodes with roughened surface were tested for straight 16 days, 500  $\mu$ A, 200 micro-seconds width stimulation for 2.8 billion cycles. The authors noticed some protein debris adsorbed on the surface of platinum electrodes, and there was no change in charge storage capacity.<sup>89</sup>

### *Impedance due to involve factors between skin and electrode and inside the body muscles*

The impedance may be present inside the electrode, inside the body and during connection between human body and electrode. The impedance of skin-to-electrode impedance works a pivotal role to facilitate effective electrostimulation. Effective electrostimulation requires careful consideration of ways to monitor the impedance of skin-electrode contact, physical conditions and environmental elements which may affect greatly on the impedance of skin and electrode contact points. Impedances, which exist within electrode interference and skin that contain skin surface.<sup>90</sup> Skin characteristics including the level of charged particles, water content, the existence of dead tissue, fat, sweat, etc., are major contributors to the interface impedance. External factors environmental moisture, air gaps, pressure, and body weight on electrodes, the position of the electrode, measurement time and individual differences all contribute significantly on the impedance value of skin-electrode contact point.<sup>91</sup> Moreover, within the body, impedance at the interface is depends upon tissue composition, muscle type, fat contents, and the distance traversed by muscles during electrotherapy. Recommended textile electrodes introduce resistance between skin's surface and conductive fabric. The electrical current flow through the fabric, due to the conductive coating materials (flow of electrons), while the current flows inside the body through the ions (present in the form of salts). Factors other than impedance of electrode material determine the impedance value between the human body and the fabric's out-of-plane. The electrode functions as a transducer, converts ionic currents into electronic ones and vice versa. Charge carriers do not traverse the interface; rather, the movement of charged particles within the body generates a time-varying electrical field, causing the redistribution of free electrons on the metal side.<sup>92</sup>

*The effect of moisture over the impedance.* Environmental moisture may affect the impedance during placement of electrodes over the skin. Maintaining low impedance between electrode and skin is crucial as it effect the signal-to-noise ratio (SNR) and lower the impact of external noise or signal artifacts.<sup>93</sup> However, moisture appears in the form of sweat (comes out during perspiration) may contain a range of salt ions. These ions in turn increase the skin electrodes impedance. Skin conductivity and hydration could increase by humidity.<sup>94</sup> Moreover, due to the sweat accumulation the humidity level may change that leads to variation in the conductivity of the dielectric layer.<sup>95</sup>

*The effect of airgaps between skin and electrode over the impedance.* The performance of dry electrodes may be influenced by electrode material and air spaces on skin. In the absence of electrolyte/sweat, the greater stratum corneum impedance makes the collection of high-quality signals with dry electrodes extremely difficult, especially in those with dry skin. To overcome the high stratum corneum impedance, researchers proposed micro tips/pin-based contact electrodes. The surface of the electrodes comes in contact with the skin and consists of pins/spikes with a height of the order of 150  $\mu\text{m}$ ,<sup>96</sup> which is sufficient to penetrate the 20  $\mu\text{m}$ -thick stratum corneum. This technique overcomes the stratum corneum's high resistance, and the charge transfer mechanism is comparable to that of wet electrodes.<sup>97</sup> Dry electrodes have slightly different skin impedance models than gel

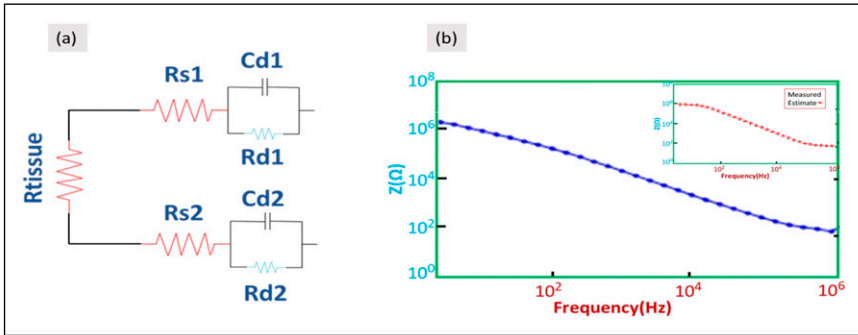

**Figure 9.** (a) An illustration of impedance at skin-electrode contact point, (b) Frequency response of skin-electrode impedance. Reproduced from Bahar Taji et al. (2014), [Impact of Skin Electrode Interface on Electrocardiogram Measurements Using Conductive Textile Electrodes]; published by [IEEE Transactions on Instrumentation and Measurement] Reproduced with permission from Copyright Clearance Center (license no. 6050281405672).<sup>14</sup>

electrodes due to accumulated air gaps and hairs, which result in capacitive and resistive coupling with the skin. On the other hand, gel-based and semi-dry electrodes permit resistive coupling.<sup>98</sup>

**Dimities effect on skin electrode impedance.** The impact of various forms of dermises, fat contents, age and gender are some more human factors, easily create signal to noise problems during measurement. The human skin typically comprises of three layers such as epidermis and dermis viable the stratum corneum (SC). Moreover, some skin appendages including hair follicles and sweat glands are also present in horizontal direction.<sup>93</sup> Stratum corneum is the primary outer layer which serves as the main barrier in any transdermal transport.<sup>99</sup> It is primarily made up of dead cells known as corneocytes that lack nuclei and are embedded in an organized and dense matrix composed of lipids. The moisture level of this layer is maintained at 20%. The structure and configuration of this layer is considered to be the defining factor of hydrophobic characteristics of the skin,<sup>100</sup> along with the narrow transport pathway that is associated with higher skin impedance. This high impedance due to stratum corneum (SC) can be recorded at frequency lower than 1000 Hz.<sup>101</sup> Moreover, the saturated lipids including cholesterol, fatty acids and ceramides act as additional permeability barrier. Therefore, the characteristics of stratum corneum (SC) i-e its unique physiological configuration influences the skin impedance measurement and also the assessment of permeability of skin, which requires further research and study. A study examining the behavior of impedance in relation to the subcutaneous fat layer has indicated that fluctuations in impedance may result from alterations in the conducting medium (such as subcutaneous fat layer, skin, connective tissues and muscle) or from changes in geometric variables.<sup>102</sup> Various observations have been conducted to determine the potential impact of fat on EIM outcomes. In one study, Garmirian et al. claimed that, in general, the impacts of fat would be negligible, with the possible exception of obese patients.<sup>103</sup> Furthermore, a specific study identified bio-impedance disparities in obese subjects through morphometric analysis of various tissue

compartments using MRI.<sup>104</sup> Furthermore, they discovered no apparent change in SFL thickness among female and males. Additionally, no gender effects of SFL thickness were found on upper limb EIM by another researcher.<sup>105</sup> However, Sung et al. claimed that a significant amount of current will pass via fat at the locations nearest to the voltage measurement when currents pass through tissues beneath the power-measuring devices.<sup>106</sup> The electrochemical characteristics of the different human skin behaves different; which effect on connection between the skin and electrodes. A recent research study suggested a way to model and evaluate the relationship between textile electrodes and skin tissue modeling using electrochemical techniques.<sup>14</sup> The measurements are presented in Figure 9(a) and (b), demonstrating two electrodes and their interaction with user's tissue. R tissue shows the impedance of tissues between two electrodes. The two similar electrodes constituted of stretchable conductive fabric made from medical-grade Dorlastan (8%) and silver-plated nylon (92%) were used. In the upper middle arm of a healthy human, the tissue impedance ( $R_{\text{tissue}}$ ) is almost  $150 \Omega$ , while the resistance of the electrodes on the skin is greater than  $1 \text{ M } \Omega$ .

**Pressure effect on impedance.** The resistance at the junction between the electrode and the skin at the interface between the skin and electrode also primarily influenced through pressure. Applying pressure to the electrode could increase the interaction, that leads to decrease in resistance. As the dry textile electrodes showed lack of adhesion, the quality of recorded bio-potential signals can be improved by applying appropriate pressure to sustain skin-electrode interaction.<sup>107</sup> Consequently, the impact of pressure on skin-electrode impedance was examined in a recent study. The study utilized flat textile substrates comprised of silver yarn and tested, 20 mmHg, pressures of 10 mmHg and 30 mmHg ( $\sim 1.33 \text{ KPa}$ ,  $\sim 2.66 \text{ KPa}$ , and  $\sim 3.99 \text{ KPa}$ , respectively), falling within the recommended pressure range for electrode compression applications.<sup>108,109</sup> It may be observed that the resistance of dry fabric electrodes with various conductive coating materials was not significantly affected by pressure (as shown in Figure 6). The subsequent ECG measurement was taken at a pressure of 20 mmHg ( $\sim 2.66 \text{ KPa}$ ), It has been demonstrated that for ECG applications, this pressure provides superior signal fidelity.<sup>110</sup>

**Effect of weight over impedance.** Moreover, different weights were applied over seven different conductive electrodes and dry and wet conditions. The impedance–frequency values under different load weights were evaluated. The sudden decrease in impedances values from  $400 \Omega$  to  $50 \Omega$  was observed. Due to the pressure more, impaction and more flow of electrons is estimated due to the close proximity of conductive web.<sup>111</sup>

**Effect of temperature.** In aforementioned studies based on gel electrodes, it has been demonstrated that the capacitive and resistive property of skin-electrode interface becomes higher with the decrease in temperature. Such study was carried out with the temperature range between  $26$  and  $36^\circ\text{C}$ . This variation in impedance is related to the temperature changes rather than the fluctuations in flow of blood.<sup>112</sup> In a research study, the temperatures were maintained at  $23^\circ\text{C}$  i-e room temperature and, no alterations were

**Table 4.** Impedances involve due to skin and electrode and inside the body muscles and recommendations for effective electrostimulation.

Sr. no.	Material/substrate/object name	Limitations regarding the transmission of electrical signals or due to the involved impedances	Ref.
1	Limb position	It is better to place limb in a way that it is located in the center of muscle distance. In this way it induces optimum contraction of muscle along with lowest possible impedance. It is advised to avoid shortened and lengthened position of limb in order to achieve efficient electrostimulation.	161
2	Voluntary contraction of patients	The voluntary contraction by patients, along with motor imagery (visualizing about muscle contraction) and electrotherapy seems to present better response towards the plasticity of motor cortex (post-stroke) as compared to just focusing on exercise or electrical stimulation process. Therefore, in this way the use of proper device, and even distribution of signals by avoiding the unnecessary impedances are most important.	162
3	Motor point	The electrodes should be carefully positioned where motor points are present. It is because the contractions induced on these points require less current amplitude and impose minimum resistance or impedance to muscles.	163
4	Denervated muscles	This happens during motor nerve depolarization and not by any other factor directly affecting fibres of muscles. Therefore, it needs to provide longer phase duration of NMES pulse such as 100 to 300 ms approximately and consequently demands more electrical charge in order to induce contraction. For this purpose, it is important to select right position and appropriate device for electrostimulation.	164
5	Skin surface	The reduction in impedance during longer procedures of electrostimulation depends upon the skin that is present below the electrode and becomes extraordinary hydrated. This happens because of the gradual increase in ions (due to diffusion) and sweat that is trapped beneath the electrode.	165
6	Fat contents in the demits	The layer of fats under skin surface acts as an electrical dielectric. These fat content induces capacitance because of its property of electrical impedance. This capacitance is produced by greater conduction through skin (low barrier) and high conduction through muscles (low resistance) that are separated by layer of fat.	166

(continued)

**Table 4.** (continued)

Sr. no.	Material/substrate/object name	Limitations regarding the transmission of electrical signals or due to the involved impedances	Ref.
7	Subcutaneous fats	Among those individuals who are obese and possess thick subcutaneous fat layer, this factor of capacitance is very important. The impact of effect of this capacitance results in creation of a time constant between charge and discharge process which ultimately modify the energy that is transmitted to muscle.	<sup>167</sup>
8	Gender difference	Impedance in female body is greater as compared to the bodies of male. This is due to the difference of many characteristics including skinfold thickness, fat content, body weight and tolerance etc.	<sup>168</sup>
9	Age effect	By comparing old and young persons, the upper extremity muscle exhibit less and negligible effect of impedance while lower extremity muscle shows major and continuous effect, with more response in men. Impedance in older individuals may be greater as compared to young person because of the possibility of more health issues in them that may affect the process.	<sup>169</sup>

induced to agar sample and the subjects being established. Consequently, we are unable to explore the impact of temperature, as the contrary direct relation of skin-electrode impedance with the temperature change was considered.<sup>113</sup> The movement of electrode and the fluctuation in impedance of electrodes due to changes in temperature is linked to the failure of electrostimulation.<sup>114</sup> According to the findings of a study, many patients indicated that the capacitive and resistive characteristics of skin-electrode resistance do not alter even if the temperature is changed between 36.0°C and 27.5. Also, there was no link among skin-electrode impedance and the core temperature. Table 4 is elaborating the limitation in electrical signal transmission due to location of organ and their involved impedance.

### *Impedance involved due to the electrostimulation devices, and operating parameters*

A wide range of devices are used to transmit the NMES signals. Most of them comprising battery operated and portable devices that are used to send NMES. There are also other composite devices that are not only send NMES but also send other various types of electrical currents and these electrostimulation techniques include TENS (Transcutaneous electrical nerve stimulation), interferential current therapy, and HVPC (high voltage pulsed current). These current therapies delivered via alternating current AC and plug-in electrical devices for the application of NMES. These devices not only provide various types of NMES but also administrated other various types of modalities like ultrasound. Typically, when employing large electrodes (for example, 10 × 13 cm), to activate several muscles, or stimulating large

muscle groups, it is important to use the devices provide higher power (more than 80 mA). If devices are not able to provide the enough power, then it is very hard to make the muscle contract smoothly. It is important for manuals of devices to include the technical details. For example, a common setting is a type of electrical signal called a classic waveform, which is a type of balanced signal that switches its polarity 2500 times per second (which accounts 2500 Hz). A kind of BMAC which is also known as Russian current is split into bursts that remains for 20 milliseconds. These bursts comprise current of 10 milliseconds provided through AC current (half cycle) and this current is monitored by 10 milliseconds of non-AC that complete half cycle. Hence provide the 50% of duty cycle and repeats about 50 times in a second because of this technique maintain the eruption rate of 50). The carrier frequency running in the background with constant of 2500-Hz AC. In recent times, various therapy devices are generated to give different range of currents, including traditional Russian current, that allow to adjust the things such as carrier frequency (between 1000 5000 Hz), burst frequency (between 50 and 75 bursts per second), or burst duration (between 2 and 10 milliseconds). Normally, wall-powered stimulators are the ones that provide therapeutic currents which change over time. Instead of it, operating parameter such as frequency range, time of repeated impulses and range of applied current may also effects on impedance. The impedance assessment of dry textile electrodes with and without conductive filler constituents screen-printed on them was deeply examined in a recent research work. To avoid intra and inter impedance differences, an agar-based skin model was developed to examine functionality of electrodes<sup>115</sup> Assessing frequency requirement, coating constituents, and agar-electrode impedance in dry textile electrodes over an extensively used frequency band (1 Hz–10 kHz).<sup>31,116</sup> Analysis followed under 20 mmHg (~2.66 kPa) of functional pressure, pretending real-world wearable ECG sensor circumstances.<sup>108,117</sup> The contact impedance modulus demonstrated a frequency-reliant on decrease, reliable with the distinguishing behavior of electrical impedance restrained on human skin.<sup>118</sup> In another study, a significant effect of frequency against the impedance was noted on dry textile electrodes. At same pressure level 20mmHg the electrodes impedance dropped rapidly at 1 kHz as compared to 5 Hz.<sup>119</sup> The contact impedance modulus reduced with accumulative frequency, subsequent the characteristic tendency of skin impedance quantities. Moreover, the [Table 5](#) is showing the impedance involved due to the electrostimulation devices, and operating parameters.

## **Electrode types and impedance variations across different electrostimulation modalities**

Electrical stimulation is universally engaged to treat numerous nerve/muscle wounds and accomplish both acute and chronic pain circumstances. This comprises the transmission of electrical pulsation to muscle or nerve for the determination of triggering impulsive tissue with the help of either interior or exterior electrodes. The aim of this procedure is to insincerely build muscle power which generate or support limb drive and reduce the pain.<sup>120</sup> Several kinds of textile electrodes including printed electrodes with conductive materials, nonwoven electrodes having conductive fibers, embroidery-based electrodes, etc. propose many advantages when compared to the disposable surface electrodes (used conventionally) as they are quite flexible, reusable and do not need hydrogels. It can

**Table 5.** Devices, Equipment care and maintenance involve reducing the impedances during effective electrostimulation.

Sr. no.	Material/substrate/object name	Limitation with respect to flow of electrical signals or involved impedances	Ref.
1	Type of device being used	A wide variety of device such as TENS, NMES, HVPC and interferential current therapy are normally used. All devices give various range of voltages, impulses, current and frequencies. The recommendation of device should be in accordance to type of muscle, or electrotherapy or electrodes used in combinations.	170
2	Electrodes attached with device	For disinfection, use washing protocols. The unnecessary resistance will be increase due to the accumulation of oil, contamination and grease. However, the washing and reusing of dry textile electrodes is recommended as there is no effect on the increase in impedances is observed.	171
3	Device with adjustable current and frequency	Instead of old fashioned commercially available devices, new devices are available with modifiable levels of carrier frequency ranging from 1000 to 5000 Hz, burst frequency from 50 to 75 bursts per second, or spurt period of 2–10 ms. These devices are quite effective to adjust current flow by avoiding unnecessary impedances involved.	172
4	Portable stimulators	They provide a series of three or more balanced, biphasic, rectangular from 120 to 400 ms segment intervals isolated through a 100- $\mu$ s inter-pulse duration. These spurts consist more than three beats and carried 50 times a second. This waveform can yield near-utmost force yield while minimizing discomfort, indicating the important effect of waveform appearances	173
5	Device providing pulsed current (PC)	Pulsed current (PC) is extensively ideal for therapeutic uses, as it decreases tissue injury dangers and can be managed via convenient battery-operated devices. For instance, a 10-s muscle contraction at 50 Hz and 300 $\mu$ s pulse interval sends a total current of just 0.15 s	174
6	Device adjustment with number of electrodes	Textile electrode impedance is usually assessed via two methods: Direct detection (insignificant skin resistance $\sim$ 150 $\Omega$ , by means of two skin-surface electrodes) and reference detection. Vojkan Mihjlovic working on direct detection to measure dry electrodes' contact resistance behind the ear, enlightening its durable dependence on practical pressure	14,15

**Table 6.** Showing different manufacturing methods of electrodes, their placement site on body and field of research.

	Electrostimulation modalities	Types of dry textile electrode	Impedances Recorded	Ref	
1	FES	Printed electrodes with conductive materials		126	
2	NMES/FES		4.21 $\Omega$	175	
3	FES		5 $\Omega$	176	
4	NMES/EFS + EMG		45.6 $\Omega$	177	
5	TES		24.8 k $\Omega$	178	
6	TENS		Embroidery	75 $\Omega$	179
7	TENS			Knitting and coating	14.5 k $\Omega$
8	TENS				31
9	NMES/EFS		Nonwoven electrodes having conductive fibers	185 k $\Omega$	126
10	NMES/EFS			4.21 $\Omega$	180
11	FES	5 $\Omega$		181	
12	FES	Knitting with conductive yarns	10 M $\Omega$	119	
13	TENS		Conductive fabric	182	
	NMES/FES	Weaving	4.60 $\Omega$	180	

increase comfort level by reducing allergic reactions.<sup>121</sup> It lets the muscles to be trained without the normal neuro-stimulation or to pacify pain senses.<sup>122</sup>

Electrical stimulation is now extensively used for healing, health, and professional physical activities. It's frequently originate in gyms, clinics, and homes to improve athletic activities and backing restoration over muscle instigation.<sup>123</sup> The common types of electrical stimulation are given below:

- Transcutaneous Electrical Nerve Stimulation (TENS),
- Functional Electrical Stimulation (FES) and
- Neuromuscular Electrical Stimulation (NMES).

TENS is the used globally in pain-relief technique, bringing electrical instincts to nerves in pretentious areas to slab pain signs or stimulate endorphin production. Its pathway depend on either constraining pain diffusion to the brain or triggering the body's natural drugs.<sup>124</sup> While TENS effectiveness relics discussed, NMES is used for patient's incapable to do daily exercises due to wound, frailty, or disorder, containing post-stroke continuing pain assistance.<sup>125</sup> FES is principally used in medicinal reintegration for stroke, injury in spinal cord, or muscle weakness and paralysis, bringing electrical signals to encourage contractions and enhance flexibility, movement, and regaining. TENS/NMES may additional FES in around electro-stimulation claims (target impedance: 1–10 k $\Omega$  at  $\sim$ 1 kHz), where electrode impedance under 10 k $\Omega$  certifies high-value ECG signals, prejudiced by construction methods and conductive materials.<sup>126</sup> Electrostimulation electrode impedance differs by category and presentation; for example, printed conductive electrodes demonstrates low impedance (4.21  $\Omega$  for NMES/FES, 5  $\Omega$  for FES), suitable for stimulation. Their insignificant resistance allows effectual current

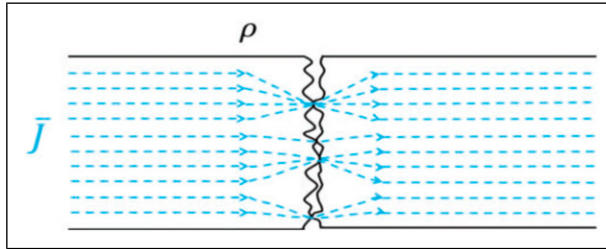

**Figure 10.** The current interface between constriction and contact point of any surface. Bahareh Taji Reproduced from Emanuel Gunnarsson et al. (2023), [Three-lead in vivo measurement method for determining the skin-electrode impedance of textile electrodes: A fast, accurate and easy-to-use measurement method suitable for characterization of textile electrodes], published by [Textile Research Journal] under the terms of the Creative Commons CC BY 4.0 license.<sup>142</sup>

distribution in therapeutic presentations.<sup>127</sup> Textile electrodes reveal extensive impedance discrepancies: embroidery-centered ( $75 \Omega$ ) and knitted-covered ( $14.5 \text{ k}\Omega$ ) for TENS, whereas nonwoven ( $4.21 \Omega$ ) and knitted-conductive yarn ( $5 \Omega$ - $10 \text{ M}\Omega$ ) aid NMES/FES. Electrode assortment disapprovingly influences stimulation effectiveness, with fabrication approaches and resources influential impedance standards (see Table 6).<sup>128-130</sup>

## Suitable models to measure the skin impedance for dry textile electrodes

### Electrical background

The electrode's effectiveness depends on its ability to conduct the current over the human skin interface. A potential electrode is categorized for its efficiency to perceive the human skin's resistance and capacitance nature. The fabric having flowing current is due to the presence of electrons, meanwhile the current in human body is due to the flow of ions. The electrode material will play an important role to determine impedance in human body and out of plane of fabric. The electrode will behave like a current convertor device which will transduce electronic current to ionic current and vice versa. The interface has no direct transfer of charge, instead movement of ions within the body will create a time dependant electrical field which will rearrange the free electrons at metal side. Therefore, it is sometime called as displacement current which is identical to the circuit models for current including capacitance, making them impedance frequency dependent.<sup>92</sup>

*Electric current and the constriction resistance between contacting points.* The interface of the skin-electrode is inherently complicated, even in the case of smooth metal surface which come into contact with each other, while in case of textile, having rough surface, which do not contact with each other will behave like a parallel capacitor with the and t constriction with the nature of resistance.<sup>131</sup> Figure 10 represent the interface of constriction and contact point of any surface.

The majority of mating contact elements can be characterized usually by their electrical resistivity values. In case of time-varying current the air gaps reside in contact points behave like capacitive elements (capacitors). However, the textile electrodes being conformable to human body and comes in contact completely with skin, plays a significant role to consider the contact impedance.<sup>132</sup> Here, the produced impedance will be because of impedance created between the skin and electrode.<sup>132</sup> Therefore, dry electrodes, also known as polarizable (some time made of pure metals) typically depend mainly on displacement currents for signal transfer.<sup>133</sup>

*The magnitude and phase shifting.* The displacement currents generate time-dependent charge distribution, which alters the local electric field. This changing (dynamic) electric field induces the movement of charged particles (within the biological medium) on the other side of the interface. However, the displacement currents dominate in dry electrodes, while the wet electrodes particularly facilitate current transfer through other mechanisms, such as redox reactions occurring at the electrode surface. Hence there is no theoretical basis for assuming a direct correlation between the two parameters (sheet resistance and contact impedance). In-fact, the magnitude along with phase shifting behavior at the skin–electrode interface, normally influenced by a range of physiological factors, including sweat density, hydration level of skin, presence of subcutaneous fat and concentration of ions etc. Moreover, in addition to these biologically variable factors, the configured geometry at interphase also plays a vital role to determine the impedance at interface. Hence, its too important to propose some theoretical models (ranging in varying levels of complexity), which accurately describe the electrical behavior at the interface (between dry metallic electrodes and human skin).<sup>134,135</sup>

*Sheet resistance.* Mestrovic et al. claimed about no overall correlation between the resistance of conductive textile electrode and low skin–electrode impedance. Therefore, it is totally insufficient to measure only sheet resistance of conductive material before using it to fabricate a textile-based electrodes (textrodes).<sup>136</sup> In another study, Xiao et al. described no correlation between sheet resistance and skin-electrode impedance. Some time it is also noticed about the electrodes (textile electrodes) having low electrical resistivity showed higher values of skin electrode impedance.

Moreover, in biopotentials measurements, the conductivity of textile-based pathways—shaped by electrical design decisions such as putting high input impedance differential amplifiers usually do not have direct effect on the electrostimulation and its measurements. The parasitic effect might hinder the real evaluation of the performance of impedance. Hence, whenever the electrode impedance would be measured, it can be observed that there is no correlation between a low contact impedance and low sheet resistance.<sup>137</sup>

### *Skin-electrode impedance models*

Various models have been developed to explain the interface, including permanent or resistive and current-dependent equivalent circuits for the measurement of skin electrodes impedances. To understand the working of any model, one must understand nature of skin

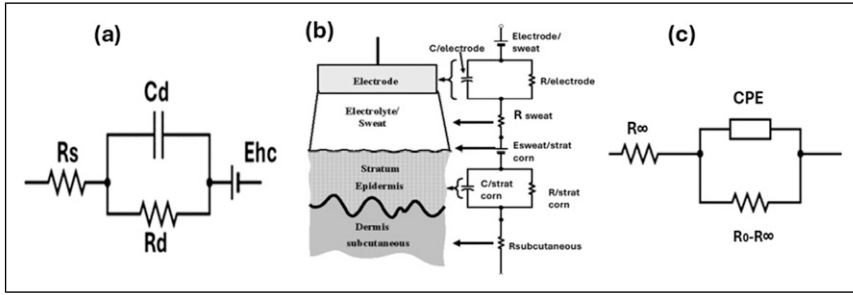

**Figure 11.** (a) Single time constant, (b) Double- time constant, (c) Cole-cole method.

which works as both resistor and capacitor. Different types of models were studied to estimate the measurements of resistor and capacitor in skin-electrode electrical models.<sup>134</sup> Three popular electrical models were studied for skin-electrodes interface. These are: (a) The single time constant, (b) The double time constant model, and (c) The Cole-Cole model.

*Single -time constant model.* Geddes and Baker suggested electrical model with a combination of resistor and capacitors in which resistors are attaches in series and a combination of one resistor and capacitor, attached in in parallel combination as illustrated in Figure 11, where  $E_{hc}$  is the cell potential,  $C_d$  is the capacitance between skin and the electrodes,  $R_d$  is the resistance between skin and electrode during charge transfer, and  $R_s$  represent total resistance and deep skin tissue resistance. This model suggest that the total impedance is frequency dependant. At lower frequency range, the capacitor act like an open circuit, hence the total impedance sums up as  $R_s + R_d$ . At higher frequencies,  $C_d$  act like a short circuit, which causes the impedance to act  $R_s$ .<sup>138</sup> The Figure 11 illustrates the different models which explains the behaviour of skin under different electrical circuits.

Reproduced from Bahareh Taji et al.(2018), [Effect of Pressure on Skin-Electrode Impedance in Wearable Biomedical Measurement Devices]; published by [IEEE Transactions on Instrumentation and Measurement] Reproduced with permission from Copyright Clearance Center (license no.6050760154839).<sup>139</sup>

*Double-time constant model.* Kaczmarek and Webster represent a more advanced method to measure the impedance value of skin-electrode contact points, which contain dual single-time constant model. The first one explains the interface of electrode and electrolyte, whereas the later one suggest the interaction between electrolyte and skin. The combination of two stages provide better results and show accuracy in bio-potential signals.<sup>140</sup>

*Cole-Cole model.* A well-known impedance measuring model which is used particularly for biological tissues, is the Cole-Cole model. Since the skin's impedance dominates the overall impedance in a double layer (double time constant) model, it is used as the skin-electrode contact impedance. The main difference is that instead of  $C_d$  (substitution of the capacitor) there exist a constant phase element (CPE), that also known as a fractional capacitor.<sup>141</sup> This component's impedance is equivalent to:

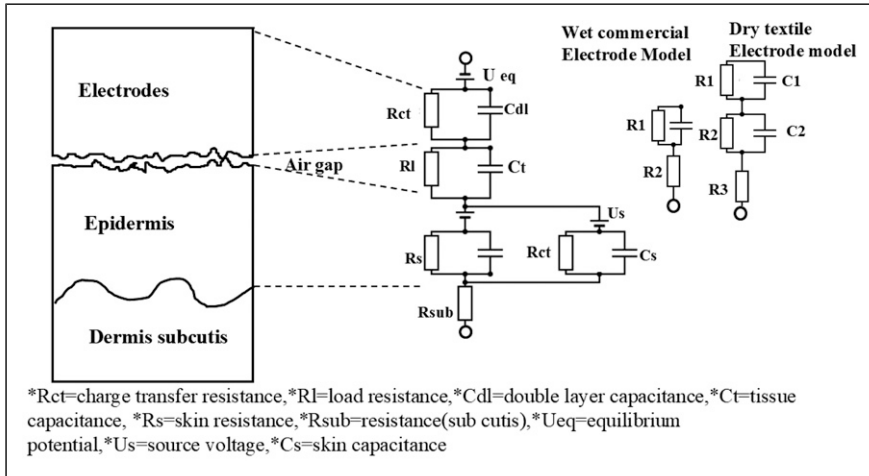

**Figure 12.** Theoretical simulated electrical circuit model for the interface of skin and electrode. Reproduced from Emanuel Gunnarsson et al. (2023), [Three-lead in vivo measurement method for determining the skin-electrode impedance of textile electrodes: A fast, accurate and easy-to-use measurement method suitable for characterization of textile electrodes], published by [Textile Research Journal] under the terms of the Creative Commons CC BY 4.0 license.<sup>142</sup>

$$Z_{CPE} = 1/(j\omega C)^\alpha$$

where C is the capacitance and  $\alpha$  is its order ( $0 < \alpha \leq 1$ ), figure presents the model equivalent circuit diagram. The introduction of Cole-Cole model against other two models explain the better durability and dependability of frequency response, and accurate impedance measurements.<sup>141</sup> Each R||C link gives rise to a specific time constant (relaxation time). However, for wet electrodes, only one time constant is used and for dry textile electrodes a model with two time-constants is particularly used.<sup>142</sup> These models are shown in Figure 12.

### In-vivo testing for skin-electrode impedance

Utilizing phantoms as an alternative source of In vivo measurements in order to get some parameters about electrode’s performance by calculating the impedance but in case of human skin, phantoms may not precisely represent the desired performance of human skin.

Rosell and McAdams have already addressed these issues earlier.<sup>91</sup> Therefore, in alignment with the recommendations of both (Rosell et al. and McAdams suggestions), During the performance evaluation of electrodes the measurement of impedance should be conducted without any skin preparation, also on various subjects and specifically on body areas recommended for application whenever features of potential electrodes are under observation. A conventional technique to measure the impedance between skin and electrode is a two-lead method. However, it also presents some limitations, as it based on the assumption which involves the whole-body symmetries impedance, and the even effect of skin-electrode impedances every place over the skin.

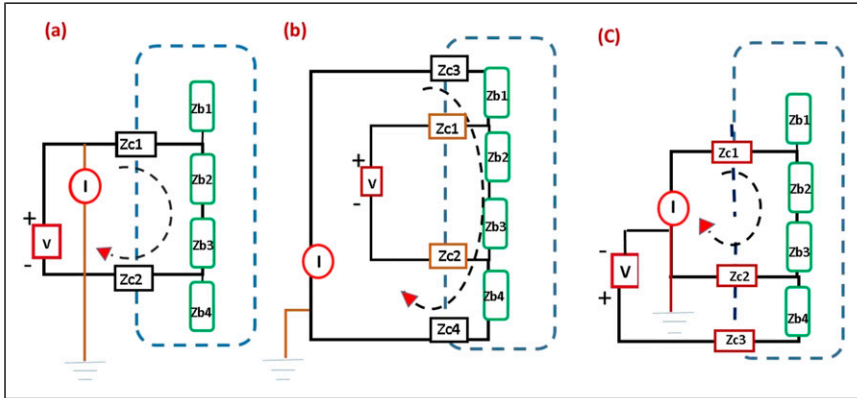

**Figure 13.** The three basic configurations for the measurement of impedance. The dashed line indicates the boundaries of the sample being measured. (a) In the two-lead measurement the value will include all impedances; (b) in the four-lead measurement only  $Z_{b2}$  and  $Z_{b3}$  will be included; and (c) in the three-lead measurement only  $Z_{c2}$  will be included. Adapted from Emanuel Gunnarsson et al. (2023), [Three-lead in vivo measurement method for determining the skin-electrode impedance of textile electrodes: A fast, accurate and easy-to-use measurement method suitable for characterization of textile electrodes], published by [Textile Research Journal] under the terms of the Creative Commons CC BY 4.0 license.<sup>142</sup>

The limitations found in the two-lead method were easily eliminated by the three-lead method. In a research study, a simple in-vivo method of three-lead was introduced to measure impedance. The study aimed to prove three-lead method as the most suitable way to overcome and eliminate the number of limitations such as, it emphasizes on the efficient characterization of textile electrodes using right, precise and reliable method other than depending on limited, insufficient and inefficient methods. Thus, the three-lead method not only overcomes the impedance of whole-body during measurements but also diminish the effect of other impedances.<sup>143</sup> The method is simple and only focuses on the impedance measurement of skin-electrode. With a complete circuit theoretical angle, during the measurement of impedance and resistance, there are three fundamental setups that can be employed. These include two-lead, three-lead and four-lead measurement methods. The first setup of a two-lead measurement includes two leads that are directly connected with the sample. In three-lead testing, three leads are directly connected with the sample and in four-lead testing, four leads are directly connected with the sample. The results in two-lead experiment record every impedance between detecting points and the voltage. The four-lead method of measurement eliminates the contact impedances while a three-lead method shows values for only a single contact interface which depends upon the geometrical arrangement of electrodes. All these three fundamental setups are shown in Figure 13 with  $Z_{ci}$  the skin to electrode number  $i$  impedance and  $Z_{bi}$  the impedance of human tissues at the location  $i$ . In these three setups, there is no current flowing in leads connected to voltmeter along the circuit because of the exceptionally high input impedance of voltmeter.<sup>143</sup> Here in two-lead method, the current passes through all impedances and therefore, the outcome in that possibility is:

$$V = (Z_{c1} + Z_{b2} + Z_{b3} + Z_{c2}) I \Rightarrow \quad (1)$$

$$\Rightarrow Z_{2-lead} = Z_{c1} + Z_{b2} + Z_{b3} + Z_{c2} \quad (2)$$

It means that the measured impedance will include the impedances between the skin and the electrodes 1 and 2 and the impedances of the human tissues at the locations 1 and 2. If in any case, impedance measurement of any material is done such as impedance measurement of human tissue and it is necessarily required not to include any interference from wires or contacts, then the method of four-lead measurement should be utilized. In the [Figure 13\(b\)](#), the measured voltage will not drop through  $Z_{c1}$ ,  $Z_{c2}$ ,  $Z_{c3}$ ,  $Z_{c4}$ ,  $Z_{b1}$  or  $Z_{b4}$  so that:

$$V = (Z_{b2} + Z_{b3}) I \Rightarrow$$

$$\Rightarrow Z_{4-lead} = Z_{b2} + Z_{b3} \quad (3)$$

The [Figure 13\(b\)](#) illustrates the arrangements of leads that defines the voltage pickup of electrodes which are attached in nearest to  $Z_{b2}$  and  $Z_{b3}$  and the current is running between  $Z_{b1}$  and  $Z_{b4}$ . As mentioned earlier, no current was running within  $Z_{c1}$  or  $Z_{c2}$  due to the high input impedance of the voltmeter. However, due to the swapping of position of current carrying electrodes and the voltage measuring electrodes, the outcomes will not be affected. By utilizing this method, anyone can measure  $Z_{b2}$  and  $Z_{b3}$  or any other combination setup of these three impedances.

In the three-lead arrangement ([Figure 13\(c\)](#)), we observe that the segment portion containing  $Z_{b4}$  is associated to a portion that does not conduct any current. It is because it belongs to the connection series of higher impedance voltmeter. That is why the impact of the higher end of voltmeter would be equal to the impact where  $Z_{b3}$ ,  $Z_{b4}$  and  $Z_{c2}$  are attached to one another such as at one edge of  $Z_{c2}$ . Hence, the voltage potential at lower part of voltmeter would correspond to that of on the other side of contact  $Z_{c2}$ . Therefore, it will be:

$$V = Z_{c2} I \Rightarrow$$

$$\Rightarrow Z_{3-lead} = Z_{c2} \quad (4)$$

From description it is clear that three-lead method represents a measured data of impedance between skin and electrode that is called as contact impedance. Also, this type of arrangement does not depend upon any assumptions about any factors. The main concept is that the input impedance of voltmeter is sufficiently great which prevents any kind of current leakage through the branch. This required factor is fulfilled by all other contemporary voltmeters. Moreover, only this arrangement can record the skin-electrode contact impedance. Other setups will merely record assumptions about the contact impedance value.<sup>144</sup> The measurement of impedance for skin-electrode contact point were measured by Ivium Potentiostat (Ivium Technologies, Netherlands) with a frequency of 1 Hz – 10 kHz. To ensure consistent testing for electrodes, which may be greatly influenced by intra and inter-person skin impedances, a human skin model was developed to determine the test results on human skin.<sup>115</sup> In short, it was done by adding 0.97% NaCl,

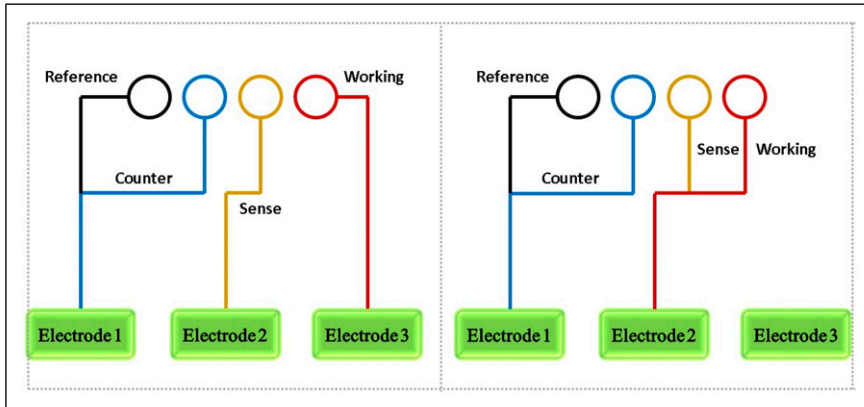

**Figure 14.** Ivium connection setup for impedance testing. (a) 3-electrode configuration, obtaining the impedance of the skin tissue (including subcutaneous tissue), which in this case would be Agar, and Electrode 1, (b) 2-electrode configuration, obtains the impedance of the skin tissue (including subcutaneous tissue), which in this case would be Agar, as well as Electrode 1 and Electrode 2. Adapted from Castrillón et al. (2018), [Electrical performance of PEDOT:PSS-based textile electrodes for wearable ECG monitoring: a comparative study] published by [BioMed Eng OnLine] under the terms of the Creative Commons CC BY 4.0 license.<sup>149</sup>

about 4.5% agar and some pure water and put it on hot plate to boil. Further, it was transferred to a container composed of glass and left until it cooled and solidified. Similarly, for each experiment, a new solution of agar was prepared by following this recipe and agar medium was only used for a maximum of 7 hours. It is because the drying of agar should be prevented to avoid its impact on the measurements of impedance. In Figure 14, three textrodes were used and positioned about 7 cm distant from each other on this agar-based skin model using the previous arrangement that is already elaborated in a studies relating to skin-electrode contact impedance.<sup>32</sup> By conducting the 2-electrode experiment, the reference (R) and counter (C) leads are attached to first electrode and the sense (S) and working (W) leads were attached to second electrode as presented in Figure 14(b). However, in 3-electrode experiment, the arrangement remains quite similar with one difference i-e the working lead (W) is attached to electrode 3, represented in Figure 14(a). The equipment provides continuous amplitude current in W and C cables, side by side detecting voltage through the R and S cables. So, the 2-electrode experiment measured the impedance due to skin tissues (also the subcutaneous layer of tissue), which is the agar of human-skin model in this condition, and in electrode 1 and electrode 2. Furthermore, the 3-electrode experiment also recorded this impedance which is also agar in this case and electrode 1. Thus, in this way the electrode 2 impedance can be recorded individually by excluding the impedance measured by 3-electrode experiment from 2-electrode experiment.

## Conclusions

The muscle atrophy resulting from paralysis and severe illness poses significant challenges to the rehabilitation and increases mortality rate. A detailed analysis on different

types of textile-based electrodes and their fabrication methods were done. The role of controlled impedance and its factors were also elaborated. Textile electrodes offer flexibility, comfort, reusability and biocompatibility, which makes them promising electrodes for like neuromuscular electrical stimulation (NMES), transcutaneous electrical nerve stimulation (TENS), and functional electrical stimulation (FES). This review focuses on the impedance variation across different modalities and it is observed that impedance value of particular electrode and stimulation method decides the efficiency of electrostimulation devices. Printed electrodes alongside conductive materials have low impedance in NMES/FES applications than in FES applications which makes them good for stimulation. Meanwhile, in TENS devices embroidery-based electrodes as well as knitted and coated electrodes have high impedance compared to the mentioned electrodes. As the non-woven electrodes with conductive fibers in NMES/EFES and knitted electrodes with conductive yarns have the same impedance value as printed electrodes with conductive materials. It was determined that the electrostimulation devices showed greater efficiency when paired with electrodes having low impedance values. Consequently, it is recommended to use printed electrodes integrated with conductive materials, non-woven electrodes with conductive fibers to enhance the effectiveness of electrostimulation. In addition, it was also concluded that only three-lead provide the best skin-electrode contact impedance, eliminating other body symmetric impedance, with accurate measurements. Hence, advancements in conductive coatings, novel fiber blends, and innovative designs could further elevate the efficiency of textile electrodes in electrostimulation fields.

### Acknowledgement

The authors of this study extend their appreciation to the Research Supporting Project, ENSAIT-GEMTEX, for supporting this study and for funding this work.

### ORCID iD

Zuhaib Hassan  <https://orcid.org/0000-0002-0174-2378>

### Author contribution

**Conceptualization**, Eman Kashita, Zuhaib Hassan **Methodology**, Zuhaib Hassan **Software** Zuhaib Hassan, **Investigation** Zuhaib Hassan and Xuyuan Tao **Validation**, Cedric Cochrane **Writing – original draft**, Zuhaib Hassan, Mahvish Fatima **Visualization**, Vladan Koncar, **Data curation**, Vladan Koncar **Supervision**, Vladan Koncar **writing—review and editing**, Eman Kashita, Mahvish Fatima, Zuhaib Hassan and Xuyuan Tao **Funding acquisition**, Vladan Koncar.

### Funding

The authors disclosed receipt of the following financial support for the research, authorship, and/or publication of this article: This work was supported by the ENSAIT, GEMTEX-Laboratoire de Génie et Matériaux Textiles, University of Lille, France.

### Declaration of conflicting interests

The authors declared no potential conflicts of interest with respect to the research, authorship, and/or publication of this article.

## References

1. Kristensen MGH, Busk H, Wienecke T, et al. Neuromuscular electrical stimulation improves activities of daily living post stroke: a systematic review and meta-analysis. *Arch Rehabil Res Clin Transl* 2022; 4: 100167.
2. Allen CB, Williamson TK, Norwood SM, et al. Do electrical stimulation devices reduce pain and improve function? —a comparative review. *Pain Ther* 2023; 12: 1339–1354.
3. Karamian BA, Siegel N, Nourie B, et al. The role of electrical stimulation for rehabilitation and regeneration after spinal cord injury. *J Orthop Traumatol* 2022; 23: 2.
4. Shin Y, Lee HS, Jeong H, et al. Recent advances in conductive hydrogels for soft bio-integrated electronics: materials, properties, and device applications. *Wearable Electronics* 2024; 1: 255–280.
5. Shaner SW, Islam M, Kristoffersen MB, et al. Skin stimulation and recording: moving towards metal-free electrodes. *Biosens Bioelectron X* 2022; 11: 100143.
6. Jafari E, Descollonges M, Deley G, et al. Comfort, consistency, and efficiency of garments with textile electrodes versus hydrogel electrodes for neuromuscular electrical stimulation in a randomized crossover trial. *Sci Rep* 2025; 15: 1–17.
7. Song H-, Lee J, Kang D, et al. Textile electrodes of jacquard woven fabrics for biosignal measurement. *J Textil Inst* 2010; 101: 758–770.
8. Tseghai GB, Malengier B, Fante KA, et al. Integration of conductive materials with textile structures, an overview. *Sensors* 2020; 20: 6910.
9. Alizadeh-Meghrazhi M, Ying B, Schlums A, et al. Evaluation of dry textile electrodes for long-term electrocardiographic monitoring. *Biomed Eng Online* 2021; 20: 1–20.
10. Polachan K, Chatterjee B, Weigand S, et al. Human body–electrode interfaces for wide-frequency sensing and communication: a review. *Nanomaterials* 2021; 11: 2152.
11. Baurley S. Interaction design in smart textiles clothing and applications. *Wearable Electronics and Photonics* 2005: 223–243.
12. Song J, Zhang Y, Yang Y, et al. Electrochemical modeling and evaluation for textile electrodes to skin. *Biomed Eng Online* 2020; 19: 27–30.
13. Zhou H, Lu Y, Chen W, et al. Stimulating the comfort of textile electrodes in wearable neuromuscular electrical stimulation. *Sensors* 2015; 15: 17241–17257.
14. Taji B, Shirmohammadi S, Groza V, et al. Impact of skin-electrode interface on electrocardiogram measurements using conductive textile electrodes. *IEEE Trans Instrum Meas* 2014; 63: 1412–1422.
15. Mihajlovic V and Grundlehner B. The effect of force and electrode material on electrode-to-skin impedance. In: *IEEE biomedical circuits and systems conference: intelligent biomedical electronics and systems for better life and better environment*, 2012, pp. 57–60.
16. Lanatà A, Valenza G and Scilingo EP. A novel EDA glove based on textile-integrated electrodes for affective computing. *Med Biol Eng Comput* 2012: 50–1172.
17. Buxi D, Sunyoung Kim, van Helleputte N, et al. Correlation between electrode-tissue impedance and motion artifact in biopotential recordings. *IEEE Sens J* 2012; 12: 3373–3383.
18. Vidhya CM, Maithani Y and Singh JP. Recent advances and challenges in textile electrodes for wearable biopotential signal monitoring: a comprehensive review. *Biosensors (Basel)* 2023; 13: 679.

19. Euler L, Guo L and Persson NK. Textile electrodes: influence of knitting construction and pressure on the contact impedance. *Sensors* 2021; 21: 1578.
20. Trayanova NA, Lyon A, Shade J, et al. Computational modeling of cardiac electrophysiology and arrhythmogenesis: toward clinical translation. *Physiol Rev* 2024; 104: 1265–1333.
21. Zhang X, Wang T, Zhang Z, et al. Electrical stimulation system based on electroactive biomaterials for bone tissue engineering. *Mater Today* 2023; 68: 177–203.
22. Nussbaum EL, Houghton P, Anthony J, et al. Neuromuscular electrical stimulation for treatment of muscle impairment: critical review and recommendations for clinical practices. *Physiother Can* 2017; 69: 1–76.
23. Popović DB. Advances in functional electrical stimulation (FES). *J Electromyogr Kinesiol* 2014; 24: 795–802.
24. Jaeger RJ. Lower extremity applications of functional neuromuscular stimulation. *Assist Technol* 1992; 4: 19–30.
25. Li G, Wang S and Duan YY. Towards conductive-gel-free electrodes: understanding the wet electrode, semi-dry electrode and dry electrode-skin interface impedance using electrochemical impedance spectroscopy fitting. *Sens Actuators B Chem* 2018; 277: 250–260.
26. Chi YM, Jung TP and Cauwenberghs G. Dry-contact and noncontact biopotential electrodes: methodological review. *IEEE Rev Biomed Eng* 2010; 3: 106–119.
27. Golparvar AJ and Kaya YM. Wearable graphene textile-enabled EOG sensing. *Proceedings of IEEE Sensors* 2017: 1–13.
28. Li GL, Wu JT, Xia YH, et al. Review of semi-dry electrodes for EEG recording. *J Neural Eng* 2020; 17: 2552.
29. Mathewson KE, Harrison TJJ and Kizuk SAD. High and dry? Comparing active dry EEG electrodes to active and passive wet electrodes. *Psychophysiology* 2017; 54: 74–82.
30. Yang L, Gan L, Zhang Z, et al. Insight into the contact impedance between the electrode and the skin surface for electrophysical recordings. *ACS Omega* 2022; 7: 13906–13912.
31. Eskandarian L, Lam E, Rupnow C, et al. Robust and multifunctional conductive yarns for biomedical textile computing. *ACS Appl Electron Mater* 2020; 2: 1554–1566.
32. Castrillón R, Pérez JJ and Andrade-Caicedo H. Electrical performance of PEDOT: PSS-based textile electrodes for wearable ECG monitoring: a comparative study. *Biomed Eng Online* 2018; 17: 1–23.
33. Sinha SK, Noh Y, Reljin N, et al. Screen-printed PEDOT: PSS electrodes on commercial finished textiles for electrocardiography. *ACS Appl Mater Interfaces* 2017; 9: 37524–37528.
34. Yang K, Freeman C, Torah R, et al. Screen printed fabric electrode array for wearable functional electrical stimulation. *Sens Actuators A Phys* 2014; 213: 108–115.
35. Zhang H, Li W, Tao X, et al. Textile-structured human body surface biopotential signal acquisition electrode. *Proceedings - 4th International Congress on Image and Signal Processing* 2011; 5: 2797.
36. Acar G, Ozturk O, Golparvar AJ, et al. Wearable and flexible textile electrodes for biopotential signal monitoring: a review. *Electronics* 2019; 8: 479.
37. Khan A, Hussain M, Nur O, et al. Fabrication of zinc oxide nanoneedles on conductive textile for harvesting piezoelectric potential. *Chem Phys Lett* 2014; 612: 62–67.
38. Garnier B, Marquez-Chin M, DiNunzio S, et al. A novel functional electrical stimulation sleeve based on textile-embedded dry electrodes. *Biomed Eng Online* 2024; 23: 1–13.

39. Ali A, Baheti V, Militky J, et al. Comparative performance of copper and silver coated stretchable fabrics. *Fibers Polym* 2018; 19: 607–619.
40. Ali A, Baheti V, Militky J, et al. Copper electroless plating of cotton fabrics after surface activation with deposition of silver and copper nanoparticles. *J Phys Chem Solid* 2018; 137: 109181.
41. Ali A, Baheti V, Javaid MU, et al. Enhancement in ageing and functional properties of copper-coated fabrics by subsequent electroplating. *Appl Phys A* 2018; 124: 651.
42. Ko F, Gogotsi Y, Ali A, et al. Electrospinning of continuous carbon nanotube-filled nanofiber yarns. *Adv Mater* 2003; 15: 1161–1165.
43. Liu X, Chang H, Li Y, et al. Polyelectrolyte-bridged metal / cotton hierarchical structures for highly durable conductive yarns. *ACS Appl Mater Interfaces* 2010; 2: 529–535.
44. Woo K, Kim D, Kim JS, et al. ink-jet printing of cu-ag-based highly conductive tracks on a transparent substrate. *Langmuir* 2009; 25: 429–433.
45. Guo R1 ZZ, Yu Y, Xie Z, et al. Matrix-assisted catalytic printing for the fabrication of multiscale, flexible, foldable, and stretchable metal conductors. *Adv Mater* 2013; 25: 3343–3350.
46. McNaughton TG and Horch KW. Metallized polymer fibers as leadwires and intrafascicular microelectrodes. *J Neurosci Methods* 1996; 70: 103–110.
47. Han EG, Kim EA and Oh KW. Electromagnetic interference shielding effectiveness of electroless Cu-plated PET fabrics. *Synth Met* 2001; 123: 469–476.
48. Xuejiao CH, Tang B, Bi C, et al. A new palladium-free surface activation process for Ni electroless plating on. *Mater Lett* 2009; 63: 840.
49. Coessens K, Pintauer V and Matyjaszewski T. Functional polymers by atom transfer radical polymerization. *Progress Polymer Science* 2001; 26: 377–2001.
50. Ali A, Baheti V, Militky J, et al. Copper coated multifunctional cotton fabrics. *J Ind Textil* 2018; 48: 448–464.
51. Ali A, Baheti V, Vik M, et al. Copper electroless plating of cotton fabrics after surface activation with deposition of silver and copper nanoparticles. *J Phys Chem Solid* 2020; 137: 109181.
52. Tseghai GB, Malengier B, Fante KA, et al. Integration of conductive materials with textile structures, an overview. *Sensors* 2020; 20: 6910.
53. Čuden AP. *Recent developments in knitting technology*. Advanced Knitting Technology. 1st ed. Cambridge: Woodhead Publishing, 2022; 13–66.
54. Dejene BK and Gudayu AD. Exploring the potential of 3D woven and knitted spacer fabrics in technical textiles: a critical review. *J Ind Textil* 2024; 54.
55. Grancarić AM, Jerković I, Koncar V, et al. Conductive polymers for smart textile applications. *J Ind Textil* 2018; 48: 612–642.
56. Kim H, Rho S, Lim D, et al. Characterization of embroidered textile-based electrode for EMG smart wear according to stitch technique. *Fash Text* 2023; 10: 1–19.
57. Elschner A, Kirchmeyer S, Lövenich W, et al. PEDOT: principles and applications of an intrinsically conductive polyme. In: *Principles and Applications of an Intrinsically Conductive Polymer*. 2010, pp. 1–380.
58. Gruyaert E, Van Tittelboom K, Backer PD, et al. Electro-conductive yarns: their development, characterization and applications. *ICSHM* 2013; 28: 196–200.
59. Bashir T. Conjugated polymer-based conductive fibers for smart textile applications. *Sensors* 2007; 7: 473.
60. Cochrane C, Koncar V, Lewandowski M, et al. Design and development of a flexible strain sensor for textile structures based on a conductive polymer composite. *Sensors* 2007; 7: 473–492.

61. Li Y, Wang S, Zhang Y, et al. Electrical properties and morphology of polypropylene/epoxy/glass fiber composites filled with carbon black. *J Appl Polym Sci* 2005; 98: 1142–1149.
62. Ding Y, Xu W, Wang W, et al. Scalable and facile preparation of highly stretchable electrospun PEDOT: PSS@PU fibrous nonwovens toward wearable conductive textile applications. *ACS Appl Mater Interfaces* 2017; 9: 30014–30023.
63. Ujiie H. Digital printing of textiles. *Digital printing of textiles*, 2006.
64. Ragab MM, Othman HA and Hassabo AG. An overview of printing textile techniques. *Egypt J Chem* 2022; 65: 761.
65. Kašiković N. Textile printing - past, present, future. *Gazette of Chemists, Technologists & Environmentalists* 2016.
66. Islam MR, Afroj S, Yin J, et al. Advances in printed electronic textiles. *Adv Sci* 2024; 11: e2304140.
67. Kim I, Ju B, Zhou Y, et al. Microstructures in all-inkjet-printed textile capacitors with Bilayer interfaces of polymer dielectrics and metal-organic decomposition silver electrodes. *ACS Appl Mater Interfaces* 2021; 13: 24081–24094.
68. Hong H, Hu J and Yan X. UV curable conductive ink for the fabrication of textile-based conductive circuits and wearable UHF RFID tags. *ACS Appl Mater Interfaces* 2019; 11: 27318–27326.
69. Shahariar H, Kim I, Soewardiman H, et al. Inkjet printing of reactive silver ink on textiles. *ACS Appl Mater Interfaces* 2019; 11: 6208–6216.
70. Kishore N. Different textile printing techniques - hand block printing, screen printing, and digital printing. *EBSCOhost* 2025.
71. Majeed H, Iftikhar T and Mukhtar U. Novel approach to water-efficient bulk industrial textile printing production of cotton fabric. *Int J Biol Macromol* 2024; 262: 130064.
72. Perera YS, Muwanwella RMHW, Fernando PR, et al. Evolution of 3D weaving and 3D woven fabric structures. *Fash Text* 2021; 8: 1–31.
73. El-Sayed E, Othman H, Hassabo AG, et al. A short observation on the printing cotton fabric using some technique. *Journal of Textiles, Coloration and Polymer Science* 2022; 19: 17–24.
74. Tseghai GB, Mengistie DA, Malengier B, et al. PEDOT: PSS-based conductive textiles and their applications. *Sensors (Basel)*. 2020; 20(7): 1881.
75. Sun J, Sun Y, Jia H, et al. A novel pre-deposition assisted strategy for inkjet printing graphene-based flexible pressure sensor with enhanced performance. *Carbon* 2022; 196: 85–91.
76. Rosell J, Colominas J, Riu P, et al. Skin impedance from 1 Hz to 1 MHz. *IEEE Trans Biomed Eng* 1998; 35: 649–651.
77. Nigusse AB, Malengier B, Mengistie DA, et al. Investigating textile-based electrodes for ECG monitoring in veterinary clinical practice. *Autex Res J* 2023; 23: 551–559.
78. Catrysse M, Puers R, Hertleer C, et al. Towards the integration of textile sensors in a wireless monitoring suit. *Sens Actuators, A* 2004; 114: 302–311.
79. Puurtinen MM, Komulainen SM, Kauppinen PK, et al. Measurement of noise and impedance of dry and wet textile electrodes, and textile electrodes with hydrogel. *Annual international conference of the IEEE engineering in medicine and biology – proceedings*, 2006, pp. 6012–6015.
80. Zhou H, Lu Y, Chen W, et al. Stimulating the comfort of textile electrodes in wearable neuromuscular electrical stimulation. *Sensors* 2015; 15: 17241–17257.
81. Levit B, Krebsbach P, Bar HC, et al. Printed soft skin electrodes for seamless bio-impedance measurements. *Flexible and Printed Electronics* 2023; 8: 5020.

82. Huang B, Zhao Z, Zheng Y, et al. 2D/3D-printed PEDOT/PSS conductive hydrogel for biomedical sensors. *Int J Bioprint* 2024; 10: 1725.
83. Mustonen T, Kordás K, Saukko S, et al. Inkjet printing of transparent and conductive patterns of single-walled carbon nanotubes and PEDOT-PSS composites. *Phys Status Solidi* 2007; 244: 4336–4340.
84. Ali A, Baheti V, Militky J, et al. Utility of silver-coated fabrics as electrodes in electrotherapy applications. *J Appl Polym Sci* 2018; 135.
85. Sci-hub | electrode materials for chronic electrical microstimulation. *Adv Healthcare Mater*, 10(12), 2100119 | [10.1002/adhm.202100119](https://doi.org/10.1002/adhm.202100119).
86. *Electrode impedance: what it is, and how it affect the quality of electrophysiological signals and electrical stimulation - an explanation for non-engineers*. Plexon. Accessed: Mar. 14, 2025. [Online]. Available:<https://plexon.com/blog-post/electrode-impedance/>
87. *Electrical stimulation and electrode properties. Part 2: pure metal electrodes*. PubMed. Accessed: Mar. 27, 2025. [Online]. Available:<https://pubmed.ncbi.nlm.nih.gov/21313789/>
88. Newbold C, Richardson R, Millard R, et al. Electrical stimulation causes rapid changes in electrode impedance of cell-covered electrodes. *J Neural Eng* 2011; 8(3): 036029.
89. Li P, et al. A study of the effect of electrochemical roughening of platinum on the sensitivity and selectivity of glutamate biosensors. *J Electrochem Soc* 2022; 169(3): 037510.
90. Li G, Wang S and Duan YY. Towards gel-free electrodes: a systematic study of electrode-skin impedance. *Sens Actuators B Chem* 2017; 241: 1244–1255.
91. Rosell J, Colominas J, Riu P, et al. Skin impedance from 1 Hz to 1 MHz. *IEEE Trans Biomed Eng* 1988; 35(8): 649–651.
92. Polachan K, Chatterjee B, Weigand S, et al. Human body–electrode interfaces for wide-frequency sensing and communication: a review. *Nanomaterials* 2021; 11(8): 2152.
93. Hansen S, Lehr CM and Schaefer UF. Modeling the human skin barrier--towards a better understanding of dermal absorption. *Adv Drug Deliv Rev* 2013; 65(2): 149–151.
94. Yokus MA and Jur JS. Fabric-based wearable dry electrodes for body surface biopotential recording. *IEEE Trans Biomed Eng* 2016; 63(2): 423–430.
95. Li D, Pu Z, Liang W, et al. Non-invasive measurement of normal skin impedance for determining the volume of the transdermally extracted interstitial fluid. *Measurement* 2015; 62: 215–221.
96. Albulbul A. Evaluating major electrode types for idle biological signal measurements for modern medical technology. *Bioengineering* 2016; 3(3): 20.
97. Dry physiological recording electrode,” 2001.
98. Hua H, Tang W, Xu X, et al. Flexible multi-layer semi-dry electrode for scalp EEG measurements at hairy sites. *Micromachines* 2019; 10(8):518.
99. Blair C. Morphology and thickness of the human stratum corneum. *Br J Dermatol* 1968; 80(7): 430–436.
100. White EA, Horne A, Runciman J, et al. On the correlation between single-frequency impedance measurements and human skin permeability to water. *Toxicol Vitro* 2011; 25(8): 2095–2104.
101. Martinsen ØG, Grimnes S and Haug E. Measuring depth depends on frequency in electrical skin impedance measurements. *Skin Res Technol* 1999; 5(3): 179–181.

102. Elia M, Fuller NJ, Hardingham CR, et al. Modeling leg sections by bioelectrical impedance analysis, dual-energy X-ray absorptiometry, and anthropometry: assessing segmental muscle volume using magnetic resonance imaging as a reference. *Ann N Y Acad Sci* 2000; 904(1): 298–305.
103. Garmirian LP, Chin AB and Rutkove SB. Discriminating neurogenic from myopathic disease via measurement of muscle anisotropy. *Muscle Nerve* 2009; 39(1): 16–24.
104. Baumgartner RN, Ross R and Heymsfield SB. Does adipose tissue influence bioelectric impedance in obese men and women? *J Appl Physiol (1985)* 1998; 84(1): 257–262.
105. Kortman HGJ, Wilder SC, Geisbush TR, et al. Age- and gender-associated differences in electrical impedance values of skeletal muscle. *Physiol Meas* 2013; 34(12): 1611–1622.
106. Sung M, Spieker AJ, Narayanaswami P, et al. The effect of subcutaneous fat on electrical impedance myography when using a handheld electrode array: the case for measuring reactance. *Clin Neurophysiol* 2013; 124(2): 400–404.
107. Maughan WL, Sunagawa K, Burkhoff D, et al. Effect of arterial impedance changes on the end-systolic pressure-volume relation. *Circ Res* 1984; 54(5): 595–602.
108. MacRae BA, Cotter JD and Laing RM. Compression garments and exercise: garment considerations, physiology and performance. *Sports Med* 2011; 41(10): 815–843.
109. Lawrence D and Kakkar VV. Graduated, static, external compression of the lower limb: a physiological assessment. *Br J Surg* 2005; 67(2): 119–121.
110. Cömert A, et al. Effect of pressure and padding on motion artifact of textile electrodes. *Biomed Eng Online* 2013; 12(1): 1–18.
111. Ravichandran V, Ciesielska-Wrobel I, Rumon MAA, et al. Characterizing the impedance properties of dry E-textile electrodes based on contact force and perspiration. *Biosensors* 2023; 13(728): 728.
112. Smith DC. Effects of skin blood flow and temperature on skin-electrode impedance and offset potential: measurements at low alternating Current density. *J Med Eng Technol* 1992; 16(3): 112–116.
113. Viby-Mogensen J. Clinical measurement of neuromuscular function: an update. *Clinics in Anaesthesiology* 1985; 3(2): 467–482.
114. Kim J, Kanter JA and Qiu M. A surgical technique for same-quadrant Ahmed-to-Baerveldt exchange. *Ophthalmol Glaucoma* 2023; 6(5): 564–565.
115. Idrissi A et al. Development of a test bench for the characterization of movement artifacts in smart textile systems. 11. *International conference on bioelectromagnetism*, 2018. DOI: [10.18154/RWTH-CONV-224931](https://doi.org/10.18154/RWTH-CONV-224931).
116. Ali A, Baheti V, Militky J, et al. Comparative performance of copper and silver coated stretchable fabrics. *Fibers Polym* 2018; 19(3): 607–619.
117. Lawrence D and Kakkar VV. Graduated, static, external compression of the lower limb: a physiological assessment. *Br J Surg* 1980; 67(2): 119–121.
118. Leleux P, Johnson C, Strakosas X, et al. Ionic liquid gel-assisted electrodes for long-term cutaneous recordings. *Adv Healthc Mater* 2014; 3(9): 1377–1380.
119. Zalar P, Saalmink M, Raiteri D, et al. Screen-printed dry electrodes: basic characterization and Benchmarking. *Adv Eng Mater* 2020; 22(11): 2000714.
120. Euler L, Guo L and Persson NK. A review of textile-based electrodes developed for electrostimulation. *Textil Res J* 2022; 92(7–8): 1300–1320.

121. Webster JG, et al. Medical instrumentation application and design. [Online]. 4th ed. Hoboken (NJ): Wiley; 2010. Available: [https://books.google.com/books/about/Medical\\_Instrumentation\\_Application\\_and.html?id=ejuvtAEACAAJ](https://books.google.com/books/about/Medical_Instrumentation_Application_and.html?id=ejuvtAEACAAJ) (2010, Accessed: 2025 21 Mar).
122. Cevei P, Cevei M and Jivet I. Experiments in electrotherapy for pain relief using a novel modality concept. *IFMBE Proc* 2011; 36: 164–167.
123. Marino AA. Applied Bioelectricity: from electrical stimulation to electropathology. J. Patrick reilly. *Q Rev Biol* 1999; 74(3): 371.
124. Dhawan A, Seyam AM, Ghosh TK, et al. Woven fabric-based electrical circuits: Part I: evaluating interconnect methods. *Textil Res J* 2004; 74(10): 913–919.
125. Krames E, Krames EPH and Rezai AR. Neuromodulation. 2018.
126. Soroudi A, Hernández N, Wipenmyr J, et al. Surface modification of textile electrodes to improve electrocardiography signals in wearable smart garment. *J Mater Sci Mater Electron* 2019; 30(17): 16666–16675.
127. Merhi Y, Betancur PF, Ripolles TS, et al. Printed dry electrode for neuromuscular electrical stimulation (NMES) for e-textile. *Nanoscale* 2023; 15(11): 5337–5344.
128. Skrzetuska E, Michalak D and Krucińska I. Design and analysis of electrodes for electrostimulation (TENS) using the technique of film printing and embroidery in textiles. *Sensors* 2021; 21(4789): 4789.
129. Euler L, Guo L and Persson NK. Textile electrodes: influence of knitting construction and pressure on the contact impedance. *Sensors (Basel)* 2021; 21(5): 1578.
130. Puurtinen MM, Komulainen SM, Kauppinen PK, et al. Measurement of noise and impedance of dry and wet textile electrodes, and textile electrodes with hydrogel. *Annual international conference of the IEEE engineering in medicine and biology - Proceedings*, 2006, pp. 6012–6015. doi:10.1109/IEMBS.2006.260155.
131. Anon et al. Electric contacts, 1974. DOI: 10.1007/978-3-662-06688-1/COVER.
132. Timsit RS. Electrical contact resistance: properties of stationary interfaces. *IEEE Trans Comp Packag Technol* 1998; 22(1):85–98.
133. Blachowicz T, Ehrmann G and Ehrmann A. Textile-based sensors for biosignal detection and monitoring. *Sensors* 2021; 21(18): 6042.
134. Beckmann L, Neuhaus C, Medrano G, et al. Characterization of textile electrodes and conductors using standardized measurement setups. *Physiol Meas* 2010; 31(20): 233–247.
135. Medrano G, Ubl A, Zimmermann N, et al. Skin electrode impedance of textile electrodes for bioimpedance spectroscopy. *IFMBE Proc* 2017; 17: 260–263.
136. Mestrovic MA, et al. Preliminary study of dry knitted fabric electrodes for physiological monitoring *International Conference on intelligent sensors, sensor networks and information*, 2007, pp. 601–606. doi:10.1109/ISSNIP.2007.4496911.
137. Xiao X, Dong K, Li C, et al. A comfortability and signal quality study of conductive weave electrodes in long-term collection of human electrocardiographs. *Textil Res J* 2019; 89(11): 2098–2112.
138. Geddes LA. Historical evolution of circuit models for the electrode-electrolyte interface. *Ann Biomed Eng* 1997; 25(1): 1–14.
139. Taji B, Chan ADC and Shirmohammadi S. Effect of pressure on skin-electrode impedance in wearable biomedical measurement devices. *IEEE Trans Instrum Meas* 2018; 67(8): 1900–1912.

140. Kaczmarek KA and Webster J. Voltage-current characteristics of the electro-tactile skin-electrode interface. *Annual International Conference of the IEEE Engineering in Medicine and Biology - Proceedings* 1989; 11(5): 1526–1527.
141. Elwakil AS and Maundy B. Extracting the Cole-Cole impedance model parameters without direct impedance measurement. *Electron Lett* 2010; 46(20): 1367–1368.
142. Gunnarsson E and Seoane F. Three-lead in vivo measurement method for determining the skin-electrode impedance of textile electrodes: a fast, accurate and easy-to-use measurement method suitable for characterization of textile electrodes. *Textil Res J* 2023; 93(21–22): 5124–5139.
143. Yoo H-J, et al. Bio-Medical CMOS ICs [electronic resource]. In: Yoo H-J and Hoof C (eds). *Integrated Circuits and Systems*, 2011. [Online]. Available: <https://ezlibproxy1.ntu.edu.sg/login?url=https://search.ebscohost.com/login.aspx?direct=true&db=cat00103a&AN=ntu.a797241&site=eds-live&scope=site> (Accessed: 17 Mar 2025).
144. Geselowitz DB. An application of electrocardiographic lead theory to impedance plethysmography. *IEEE Trans Biomed Eng* 1971; 18(1): 38–41.
145. Beckmann L, Neuhaus C, Medrano G, et al. Characterization of textile electrodes and conductors using standardized measurement setups. *Physiol Meas* 2010; 31: 233–247.
146. Zhao Y and Li L. Development of customizable conductive thermal woven textile for ready-to-wear functional collections. *Textil Res J* 2022; 92: 21–22.
147. Li Q, Zhang J, Li Q, et al. Review of printed electrodes for flexible devices. *Front Mater* 2019; 5: 433510.
148. Noh HW, Ahn CG, Kong HJ, et al. Ratiometric impedance sensing of Fingers for Robust identity authentication. *Sci Rep* 2019; 9: 13566–13612.
149. Castrillón, et al. “Electrical performance of PEDOT:PSS-based textile electrodes for wearable ECG monitoring: a comparative study,” 2018. *BioMed Eng OnLine*, 2018 Apr 21;7(1):38. doi: [10.1186/s12938-018-0469-5](https://doi.org/10.1186/s12938-018-0469-5).
150. Hunold A, Ortega D, Schellhorn K, et al. Novel flexible cap for application of transcranial electrical stimulation: a usability study. *Biomed Eng Online* 2020; 19: 1–11.
151. Hu CL, Cheng IC, Huang CH, et al. Dry wearable textile electrodes for portable electrical impedance tomography. *Sensors* 2021; 21: 6789.
152. Kaufmann S, Ardelt G and Ryschka M. Measurements of electrode skin impedances using carbon rubber electrodes - first results. *J Phys Conf Ser* 2013; 434: 012020.
153. Chavhan MP and Ganguly S. Drying stresses in precursor gel: effect on pore connectivity in carbonized form, and resulting performance in a supercapacitor electrode. *J Sol Gel Sci Technol* 2018; 88: 395–406.
154. Lambert I, Tebbs SE, Hill D, et al. Interferential therapy machines as possible vehicles for cross-infection. *J Hosp Infect* 2000; 44: 59–64.
155. Ahad MA, Baidya S and Tarek MN. Comparison of circular and rectangular-shaped electrodes for electrical impedance myography measurements on human upper arms. *Micromachines* 2023; 14: 1179.
156. Barrera CS, Piña Martínez E, Roberts R, et al. Impact of size and shape for textile surface electromyography electrodes: a study of the biceps brachii muscle. *Textile* 2022; 92: 3097–3110.

157. Brooks ME, Smith EM and Currier D. Effect of longitudinal versus transverse electrode placement on torque production by the quadriceps femoris muscle during neuromuscular electrical stimulation. *J Orthop Sports Phys Ther* 1990; 11(11): 530–534.
158. Geddes LA and Baker LE. The specific resistance of biological material-A compendium of data for the biomedical engineer and physiologist. *Med Biol Eng* 1967; 5(3): 271–293.
159. Flodin J, Juthberg R and Ackermann PW. Effects of electrode size and placement on comfort and efficiency during low-intensity neuromuscular electrical stimulation of quadriceps, hamstrings and gluteal muscles. *BMC Sports Sci Med Rehabil* 2022; 14(1): 11.
160. Yang D, Huang Q, Jiang Z, et al. Electrode design for electrotactile feedback with reduced interference to myoelectric signal. *IEEE Sens J* 2021; 21(14): 16350–16358.
161. Fitzgerald GK, Piva SR and Irrgang JJ. A modified neuromuscular electrical stimulation protocol for quadriceps strength training following anterior cruciate ligament reconstruction. *J Orthop Sports Phys Ther* 2003; 33(9): 492–501.
162. Chipchase LS, Schabrun SM and Hodges PW. Peripheral electrical stimulation to induce cortical plasticity: a systematic review of stimulus parameters. *Clin Neurophysiol* 2011; 122(3): 456–463.
163. Matsubara S, Watanabe T, Suzuki T, et al. Optimal motor point search using mm-order electrode arrays. *IEEE Access* 2023; 11: 58970–58981.
164. Gordon T and English AW. Strategies to promote peripheral nerve regeneration: electrical stimulation and/or exercise. *Eur J Neurosci*. 2016; Feb;43(3): 336–350.
165. Vargas Luna JL, Krenn M, Cortés Ramírez JA, et al. Dynamic impedance model of the skin-electrode interface for transcutaneous electrical stimulation. *PLoS One* 2015; 10(5): 0125609.
166. Roth BJ. *The electrical conductivity of tissues. The Biomedical Engineering Handbook. Joseph D. Bronzino*. Second Edition. Boca Raton: CRC Press LLC, 2000. doi:[10.1201/9781420049510.CH10](https://doi.org/10.1201/9781420049510.CH10).
167. Petrofsky J and Schwab E. A re-evaluation of modelling of the current flow between electrodes: consideration of blood flow and wounds. *J Med Eng Technol* 2007; 31(1): 62–74.
168. Bora DJ, et al. Modeling and simulation of electrical circuits to determine human body impedance 2023 5th International conference on electrical, computer and communication Technologies, ICECCT 2023. DOI: [10.1109/ICECCT56650.2023.10179800](https://doi.org/10.1109/ICECCT56650.2023.10179800).
169. Kortman HGJ, Wilder SC, Geisbush TR, et al. Age- and gender-associated differences in electrical impedance values of skeletal muscle. *Physiol Meas* 2013; 34(12): 1611–1622.
170. Devices, systems and methods for therapeutic muscle stimulation,” 2018.
171. Euler L, Guo L and Persson NK. Influence of the electrolyte concentration and amount on the performance of textile electrodes in electrostimulation: a systematic study,” 2022. DOI: [10.21203/RS.3.RS-1752713/V1](https://doi.org/10.21203/RS.3.RS-1752713/V1).
172. Bellew JW, Sanders K, Schuman K, et al. Muscle force production with low and medium frequency burst modulated biphasic pulsed currents. *Physiother Theory Pract* 2014; 30(2): 105–109.
173. Bellew JW, Beiswanger Z, Freeman E, et al. Interferential and burst-modulated biphasic pulsed currents yield greater muscular force than Russian current. *Physiother Theory Pract* 2012; 28(5): 384–390.
174. Gordon T and English AW. Strategies to promote peripheral nerve regeneration: electrical stimulation and/or exercise. *Eur J Neurosci* 2016; 43(3): 336–350.

175. Button VLDSN, et al. Principles of measurement and transduction of biomedical variables. In: *Principles of Measurement and Transduction of Biomedical Variables*, 2015, pp. 1–370. DOI: [10.1016/C2013-0-14261-4](https://doi.org/10.1016/C2013-0-14261-4).
176. Hunold A, Ortega D, Schellhorn K, et al. Novel flexible cap for application of transcranial electrical stimulation: a usability study. *Biomed Eng Online* 2020; 19(1): 1–11.
177. Liu M, Ward T, Young D, et al. Electronic textiles based wearable electrotherapy for pain relief. *Sens Actuators A Phys* 2020; 303: 111701.
178. Tseghai GB, Mengistie DA, Malengier B, et al. PEDOT:PSS-Based conductive textiles and their applications. *Sensors* 2020; 20(7): 1881.
179. McAdams E. Biomedical electrodes for biopotential monitoring and electrostimulation. In: Yoo HJ. and van Hoof C. (eds) *Bio-Medical CMOS ICs. Integrated Circuits and Systems*. Boston, MA: Springer, 2011. doi:[10.1007/978-1-4419-6597-4\\_3](https://doi.org/10.1007/978-1-4419-6597-4_3).
180. Li L, et al. Design of intelligent garment with transcutaneous electrical nerve stimulation function based on the Intarsia. *Knitt Tech* 2009; 80(3): 279–286.
181. Corley GJ, Breen PP, Bîrlea SI, et al. Hemodynamic effects of habituation to a week-long program of neuromuscular electrical stimulation. *Med Eng Phys* 2012; 34(4): 459–465.
182. Ali A, Baheti V, Militky J, et al. Utility of silver-coated fabrics as electrodes in electrotherapy applications. *J Appl Polym Sci* 2018; 135(23): 46357.